

# ALU TOP 86

TECHNISCHE INFORMATION

PROFILDRUCK

# ALU TOP 86

## PROFILDRUCK

### Inhaltsverzeichnis

Blendrahmen . . . . .	2
Pfosten - Kämpfer . . . . .	6
Flügel . . . . .	10
Profile für mehrflügelige Fenster ohne festen Pfosten . . . . .	15
Blendrahmenverbreiterungen . . . . .	17
Zubehör . . . . .	19
Artikelverzeichnis . . . . .	21
Zeichenerklärung . . . . .	23
Variantensystematik . . . . .	23
Artikelsystematik in SAP . . . . .	23
Variantensystematik in SAP . . . . .	23
Materialnummer . . . . .	23

# ALU TOP 86

## PROFILDRUCK

### Blendrahmen

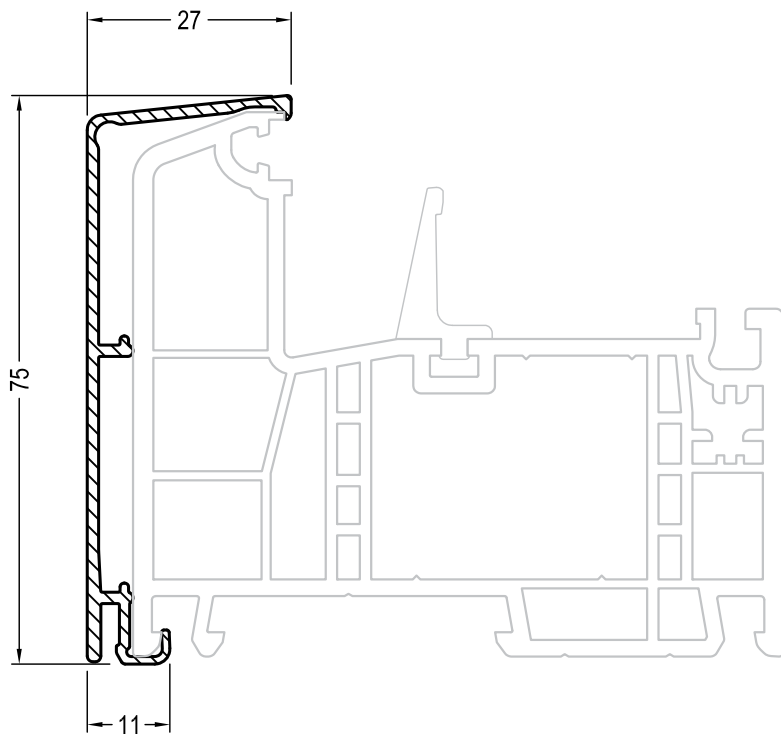

ALU TOP Blendrahmen 72 GENE<sup>®</sup>

**1209864** 

 6

Blendrahmen 72 GENE<sup>®</sup>

RAU-FIPRO<sup>®</sup>

**1532010** 

 24

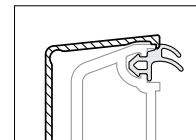

 E

 **1232881**

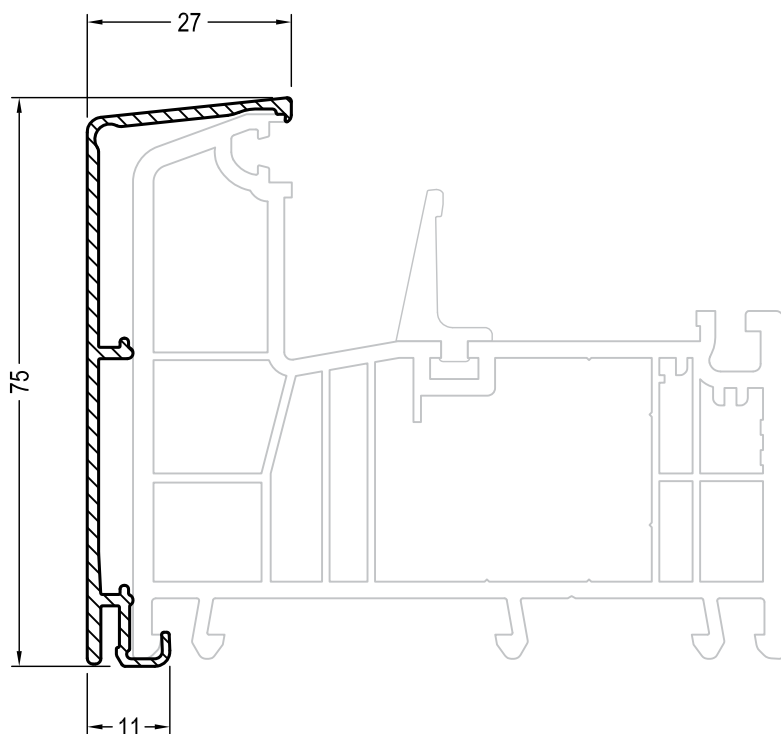

ALU TOP Blendrahmen 72

**1209864** 

 6

Blendrahmen 72

**1532400** 

 24

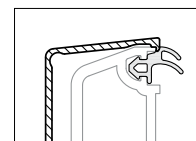

 E

 **1232881**

# ALU TOP 86

## PROFILDRUCK

### Blendrahmen

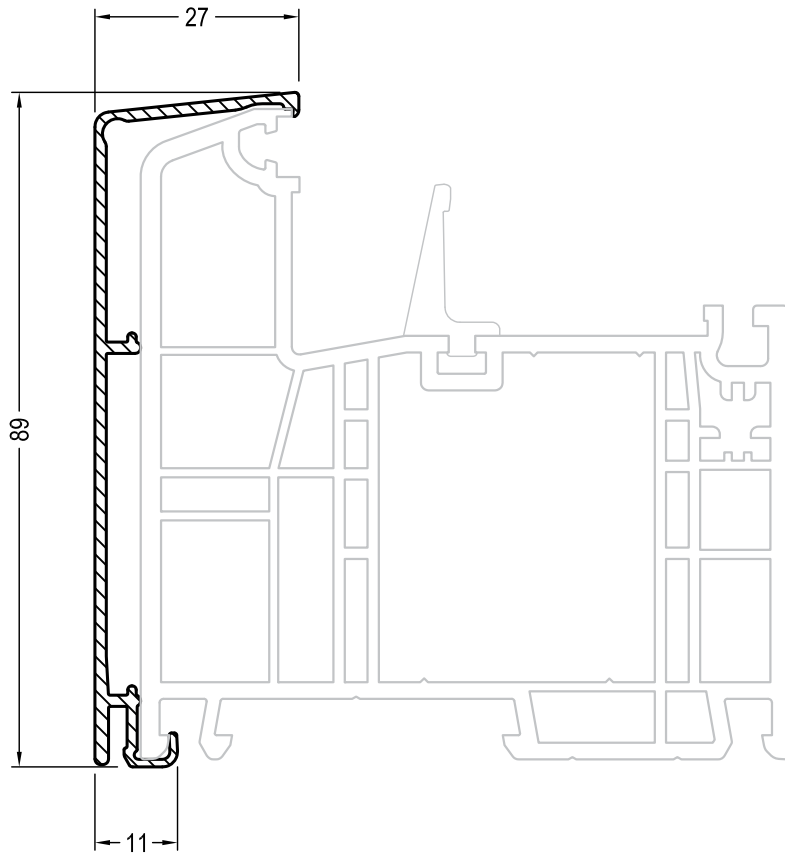

ALU TOP Blendrahmen 86 GENE<sup>®</sup>

**1209865** 

 6

Blendrahmen 86 GENE<sup>®</sup>

RAU-FIPRO<sup>®</sup>

**1532300** 

 24

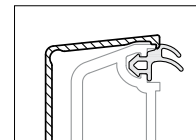

 E

 **1232881**

# ALU TOP 86

## PROFILDRUCK

### Blendrahmen

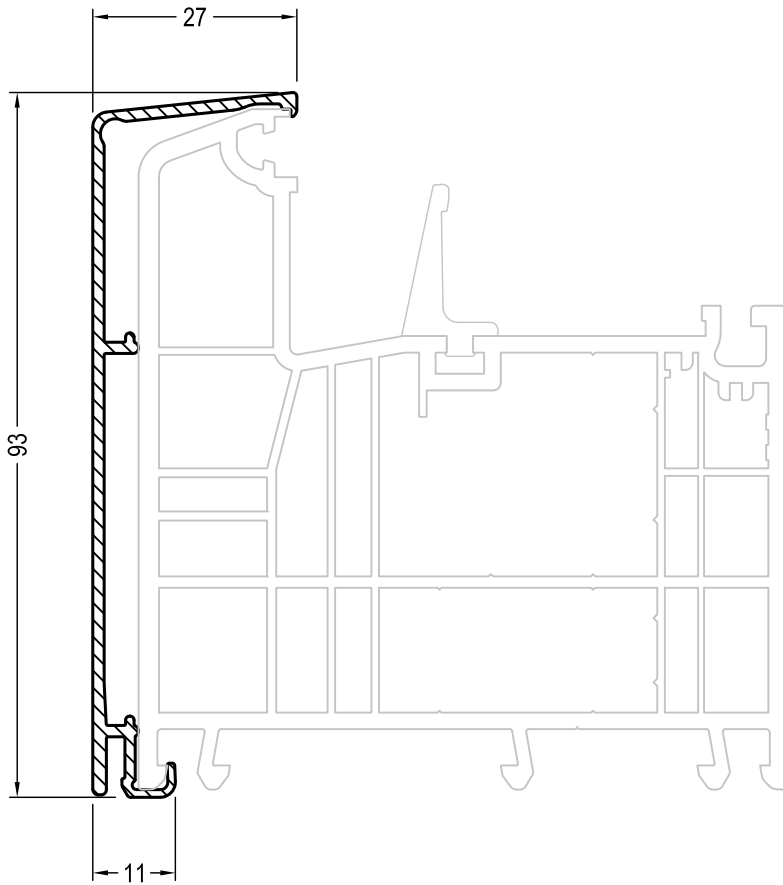

ALU TOP Blendrahmen 90

**1209866** 

 6

Blendrahmen 90

**1532450** 

 24

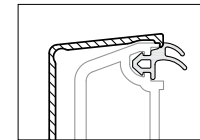

 E

 **1232881**

# ALU TOP 86

## PROFILDRUCK

### Blendrahmen

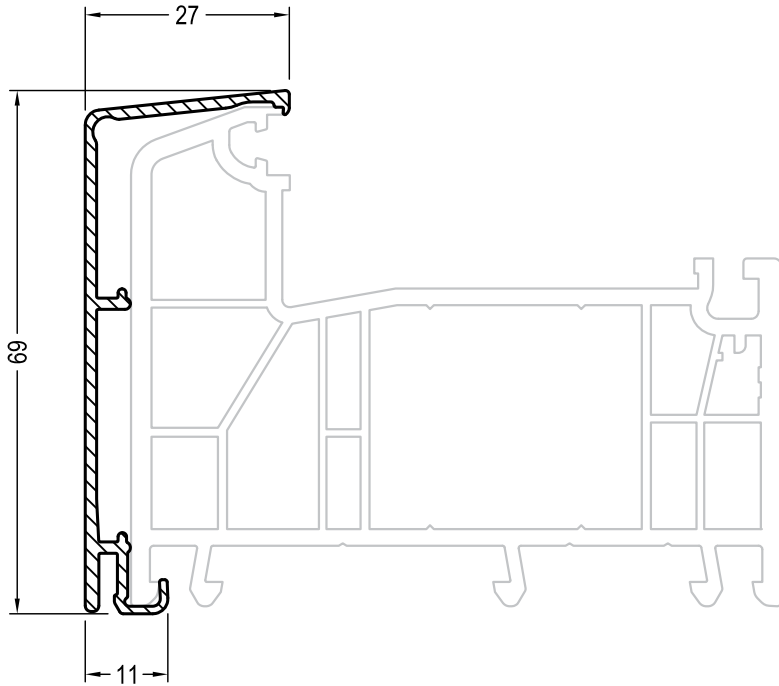

ALU TOP Blendrahmen 66 ED 86

**1209878** 

 6

Blendrahmen 66 ED 86

**1532500** 

 24

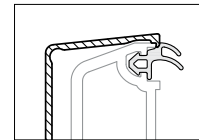

 E

 **1232881**

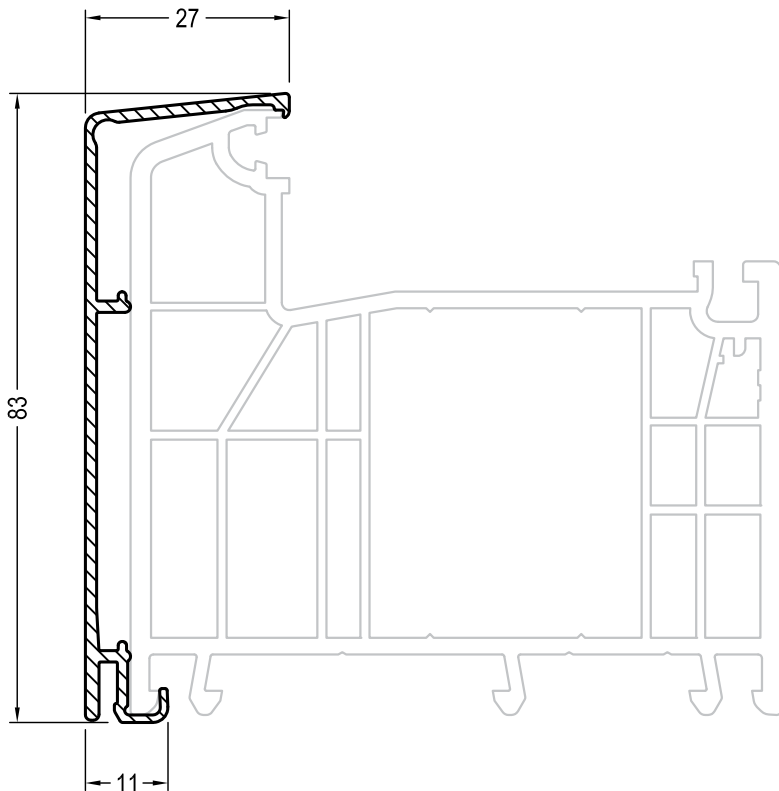

ALU TOP Blendrahmen 80 ED 86

**1209879** 

 6

Blendrahmen 80 ED 86

**1532510** 

 24

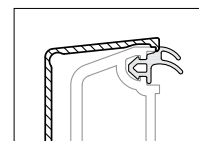

 E

 **1232881**

# ALU TOP 86

## PROFILDRUCK

Pfosten - Kämpfer

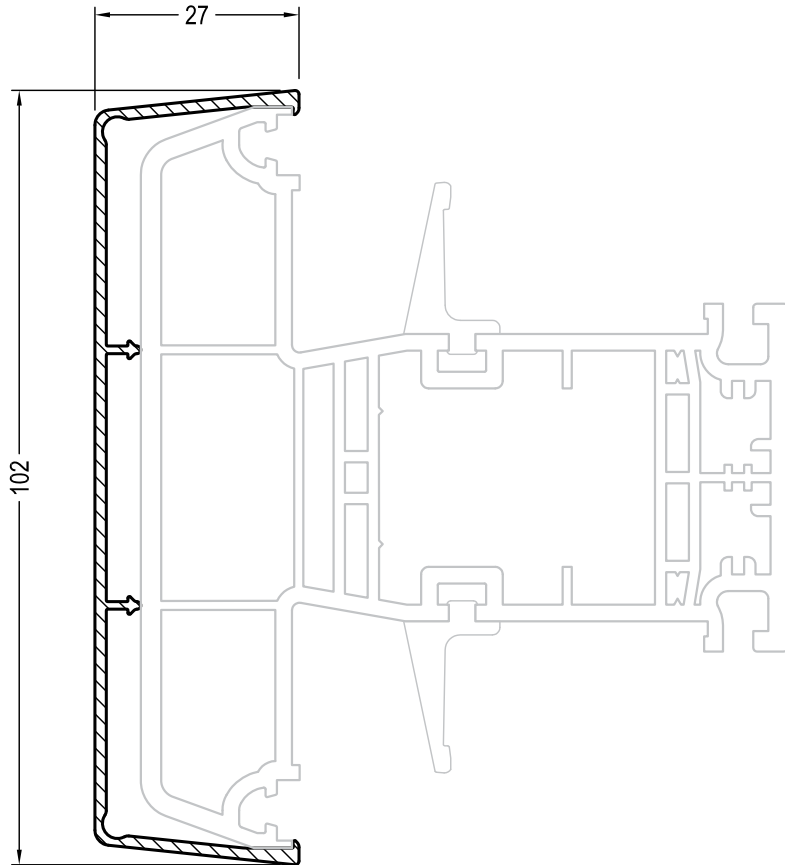

ALU TOP Pfosten 98 GENE<sup>®</sup>

**1209867** 

 6

Pfosten 98 GENE<sup>®</sup>

RAU-FIPRO<sup>®</sup>

**1532050** 

 24

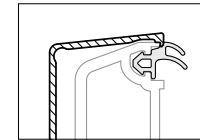

 E

 **1232881**

# ALU TOP 86

## PROFILDRUCK

### Pfosten - Kämpfer

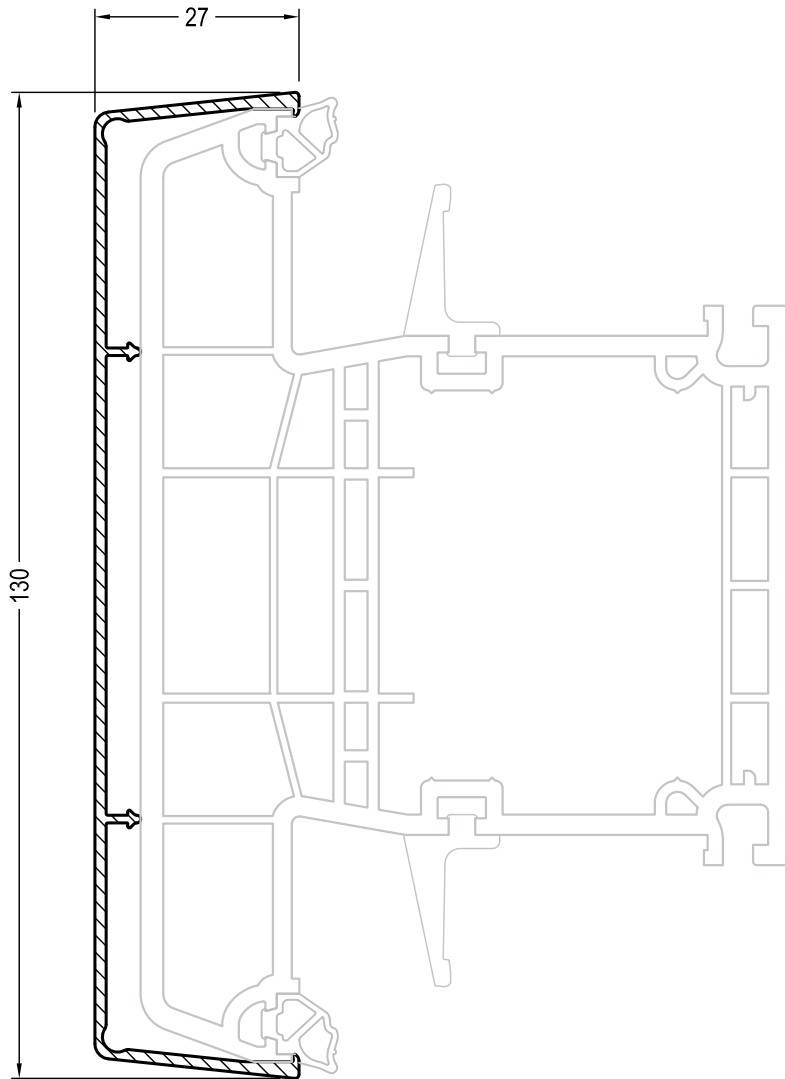

ALU TOP Pfosten 126 GENE0®

1209868 

 6

Pfosten 126 GENE0®

1532345  

 12

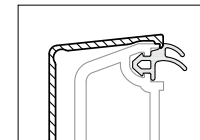

 1232881



# ALU TOP 86

## PROFILDRUCK

### Pfosten - Kämpfer

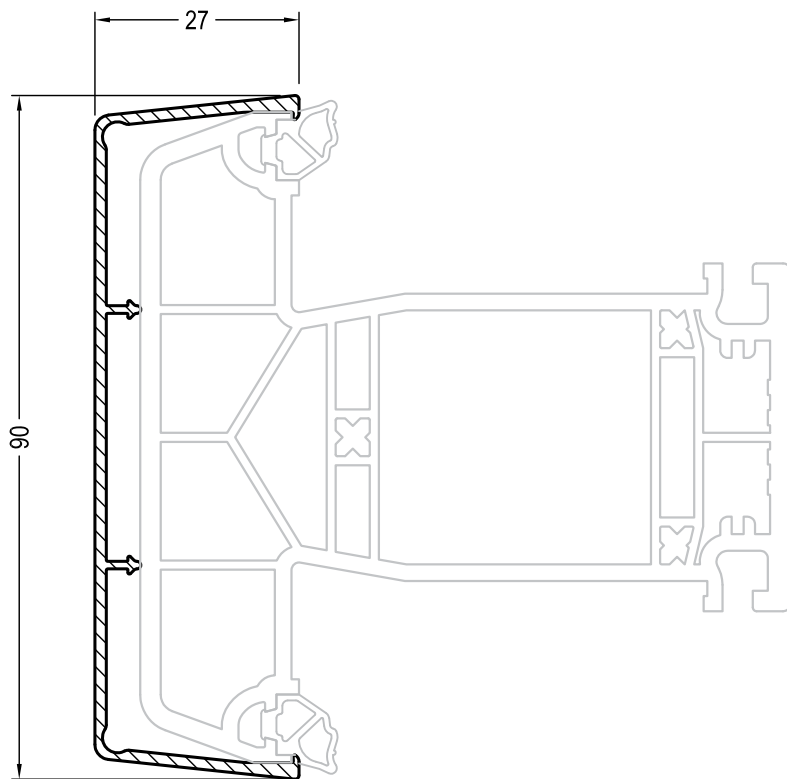



ALU TOP Pfosten 86 ED 86

**1209880** 

 6

Pfosten 86 ED 86

**1532575**  

 24

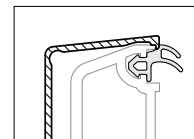

 E

 **1232881**

# ALU TOP 86

## PROFILDRUCK

### Pfosten - Kämpfer

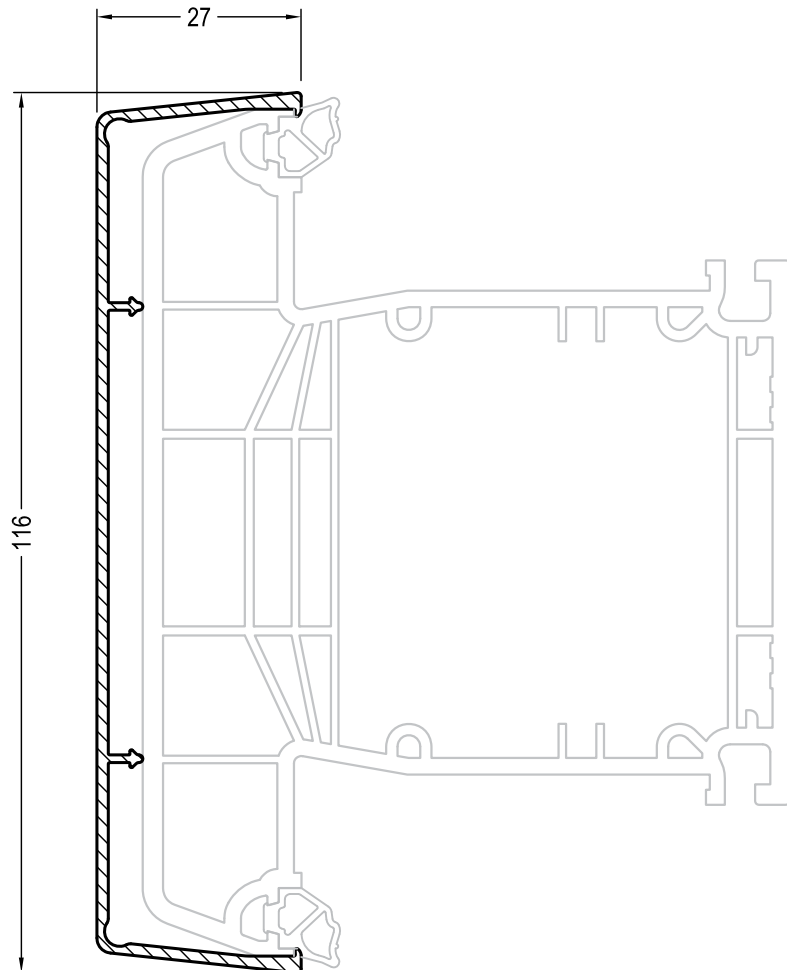

ALU TOP Pfosten 112 ED 86

**1209881** 

 6

Pfosten 112 ED 86

**1532605** 

 12

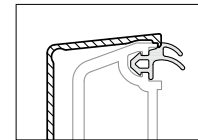

 E

 **1232881**

# ALU TOP 86

## PROFILDRUCK

### Flügel

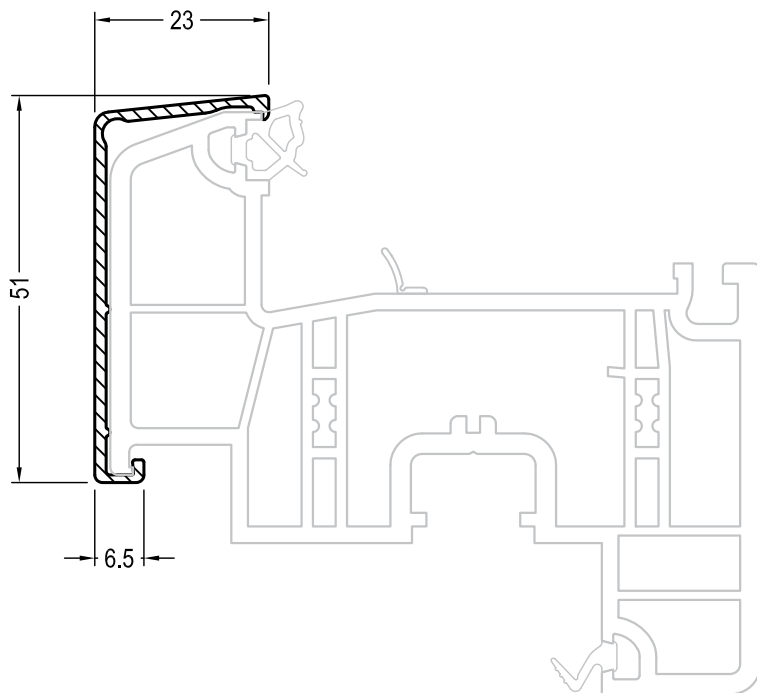



ALU TOP Flügel 57 GENE<sup>®</sup>

**1209869** 

 6

Flügel 57 GENE<sup>®</sup>

RAU-FIPRO<sup>®</sup>

**1532036**  

 24

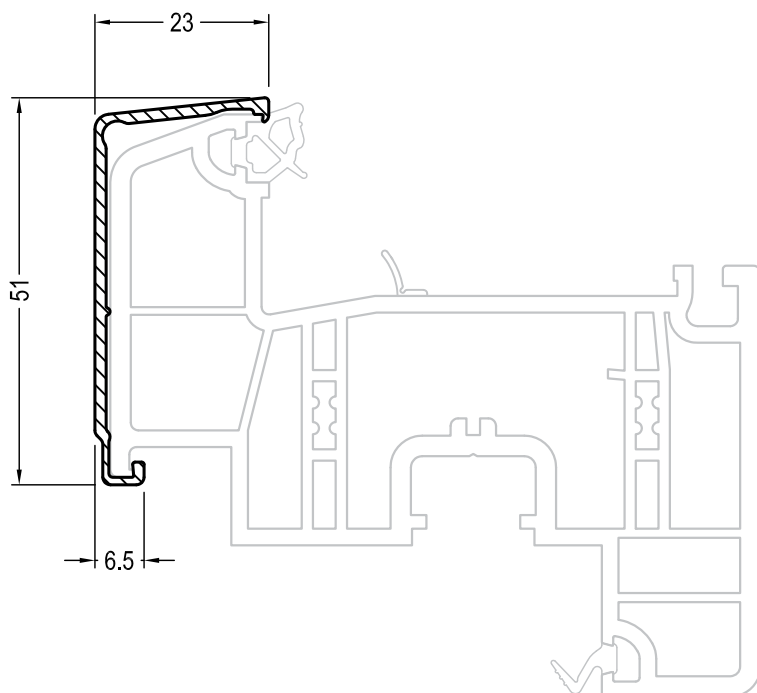

ALU TOP Flügel 57 GENE<sup>®</sup> Stulp

**1214478** 

 6

Flügel 57 GENE<sup>®</sup>

RAU-FIPRO<sup>®</sup>

**1532036**  

 24

# ALU TOP 86

## PROFILDRUCK

Flügel

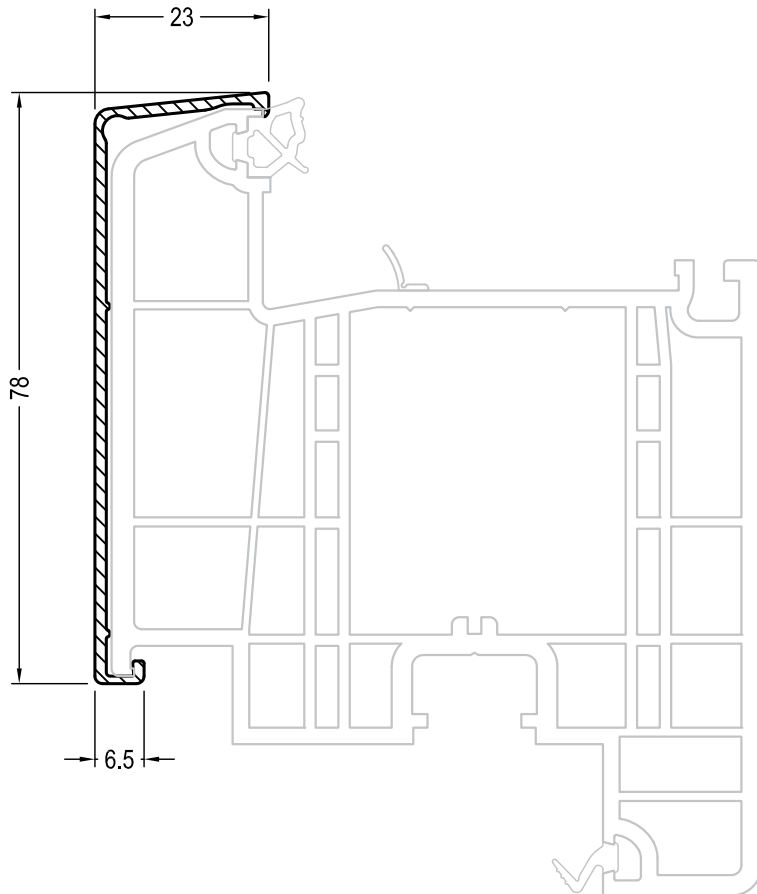



ALU TOP Flügel 84 GENE<sup>®</sup>

**1209870** 

 6

Flügel 84 GENE<sup>®</sup>

RAU-FIPRO<sup>®</sup>

**1532136**   

 12

# ALU TOP 86

## PROFILDRUCK

Flügel

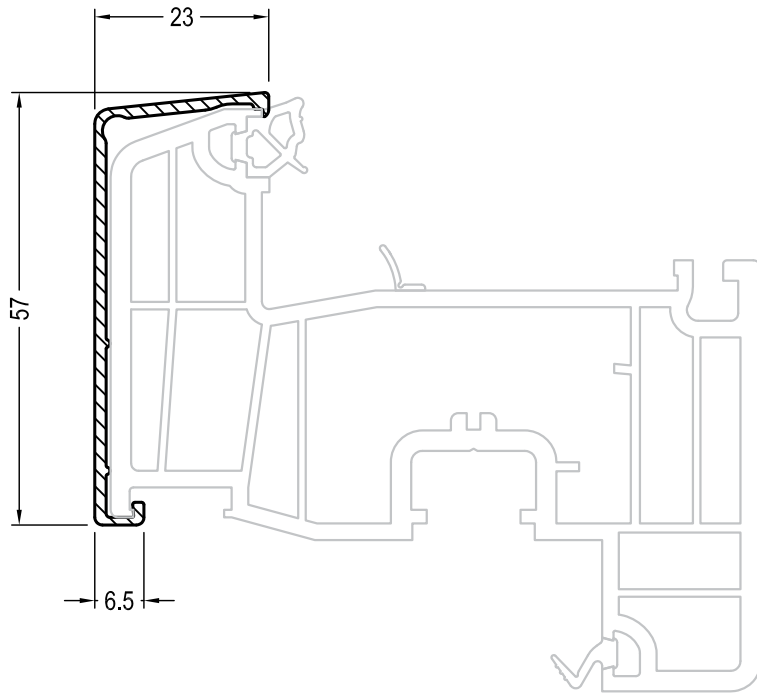



ALU TOP Flügel 57 ED 86

**1209882** 

 6

Flügel 57 ED 86

**1532526**  

 24

# ALU TOP 86

## PROFILDRUCK

Flügel

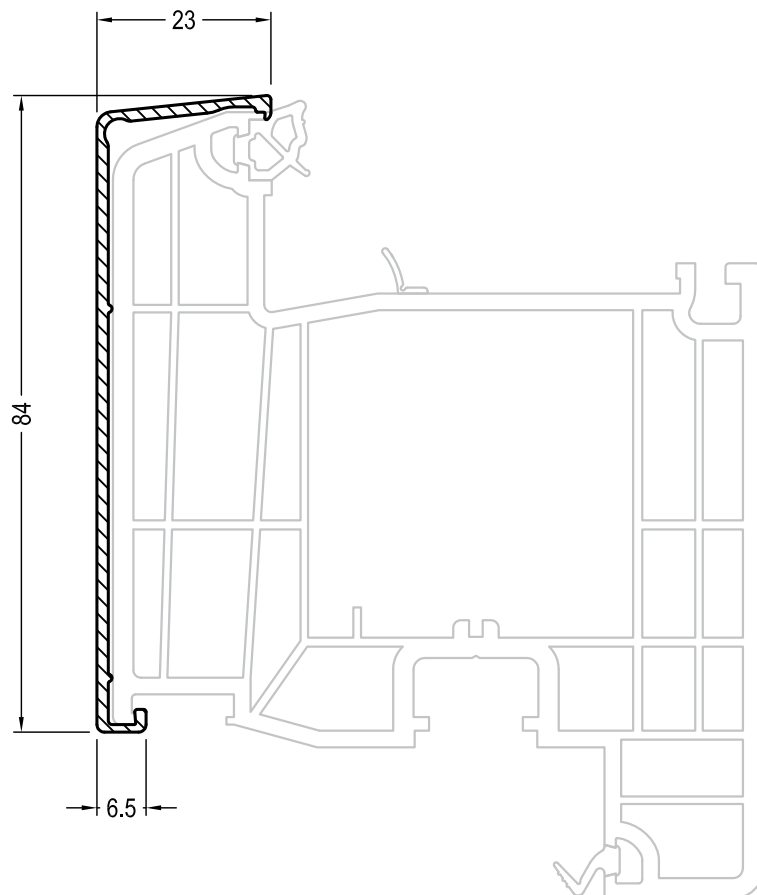



ALU TOP Flügel 84 ED 86

**1209883** 

 6

Flügel 84 ED 86

**1532546**  

 12

# ALU TOP 86

## PROFILDRUCK

Flügel

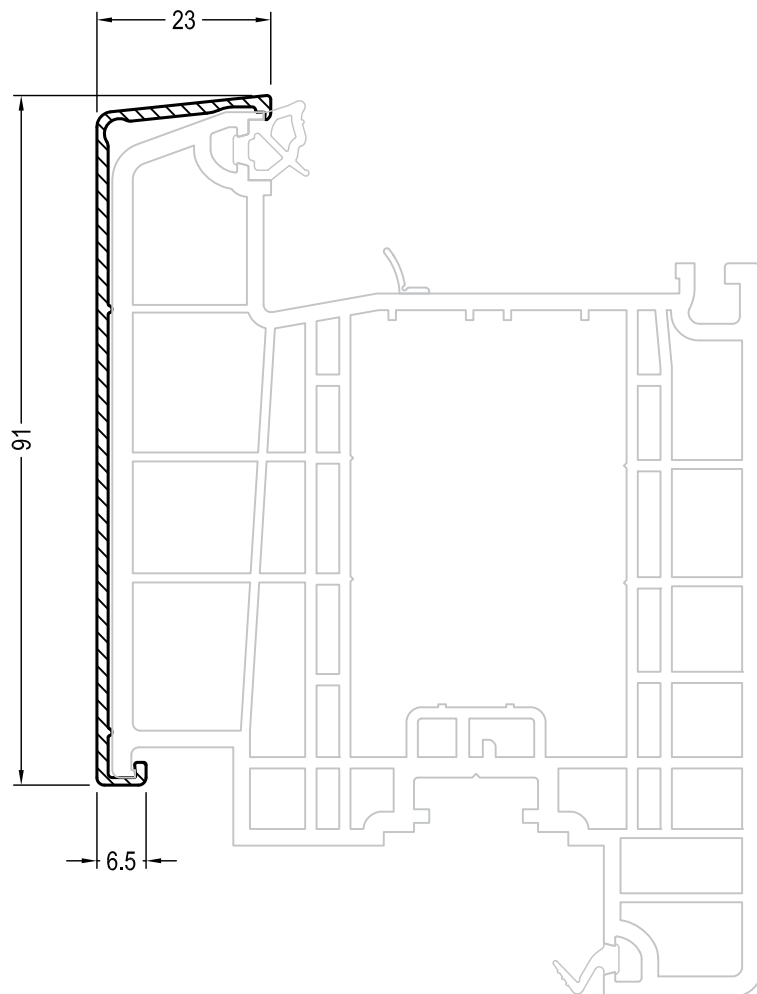



ALU TOP Haustürflügel Z GENE<sup>®</sup>

**1209872** 

 6

Haustürflügel Z GENE<sup>®</sup>

RAU-FIPRO<sup>®</sup>

**1532166**   

 13

# ALU TOP 86

## PROFILDRUCK

Profile für mehrflügelige Fenster ohne festen Pfosten

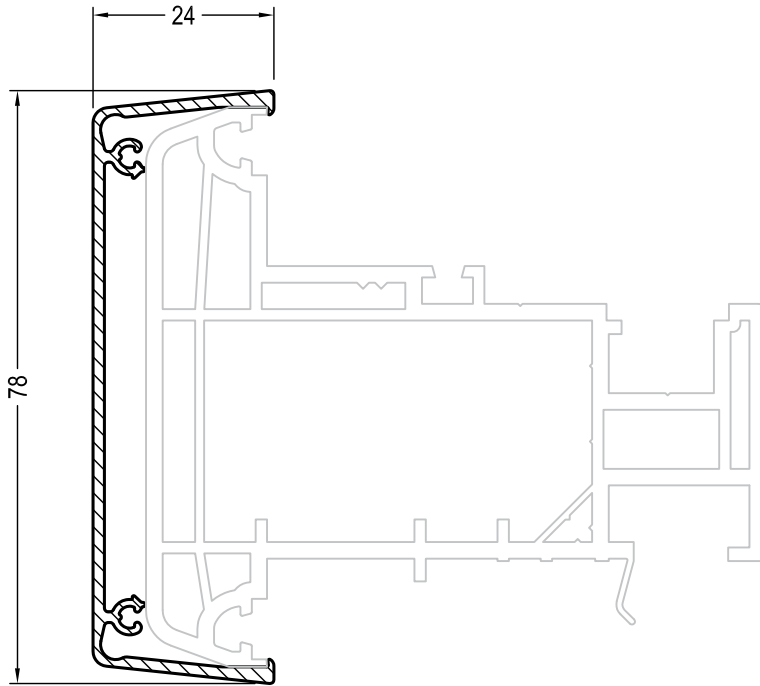

ALU TOP Blindpfosten Bautiefe 86

**1209871** 

 6

Blindpfosten Bautiefe 86

**1532080** 

 24

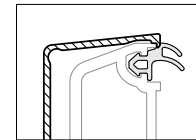

 E

 **1232881**

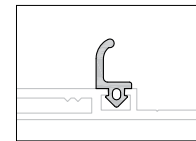



 **1211023**

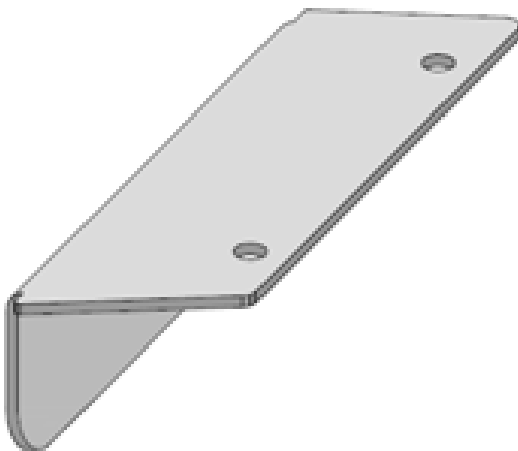

ALU TOP Endkappe Blindpfosten außen Bautiefe 86





**1305663**  

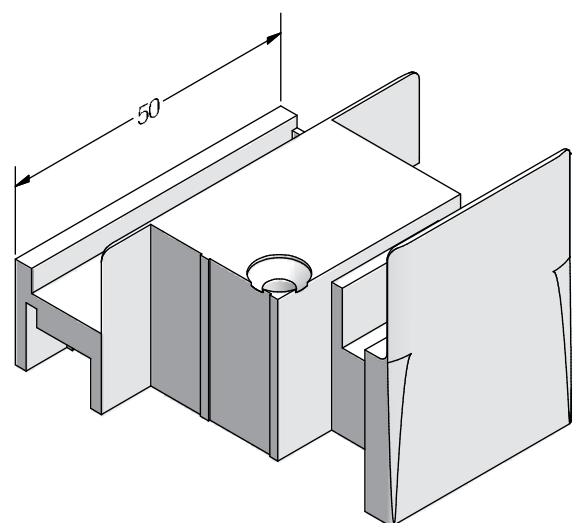

 1



Endkappe Blindpfosten innen GENE<sup>®</sup>

ASA

**1355285**  

**1355295**  

 50



# ALU TOP 86

## PROFILDRUCK

Profile für mehrflügelige Fenster ohne festen Pfosten

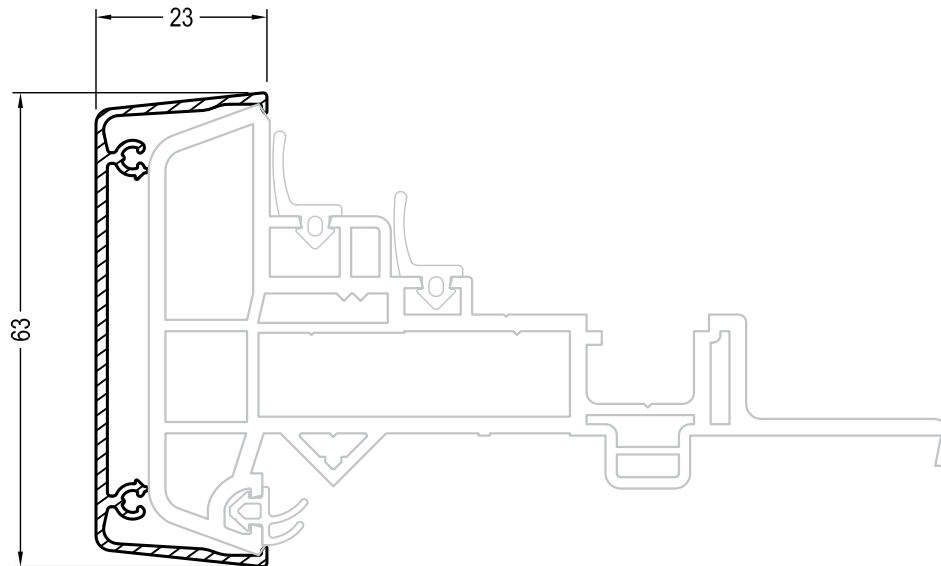



ALU TOP Stulpprofil GENE<sup>®</sup>

**1209884** 

 6

Stulpprofil GENE<sup>®</sup>

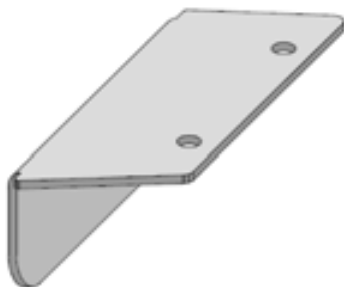

**1532075**  

 24



ALU TOP Endkappe Stulpprofil außen GENE<sup>®</sup>



**1305659**  

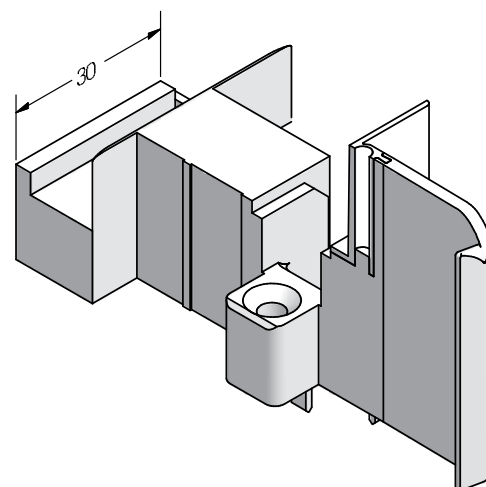

 1



Endkappe Stulpprofil innen GENE<sup>®</sup>

ASA

**1355265**  

**1355275**  

 50

# ALU TOP 86

## PROFILDRUCK

### Blendrahmenverbreiterungen

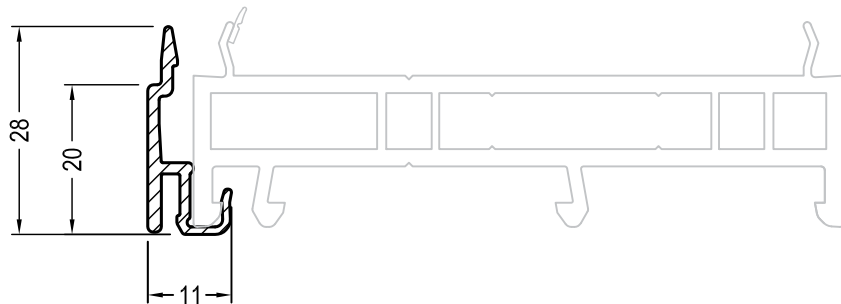

ALU TOP Blendrahmenverbreiterung 20

**1209873**  @

 6

Blendrahmenverbreiterung 20/86 mit IDS

**1533125** 

 36

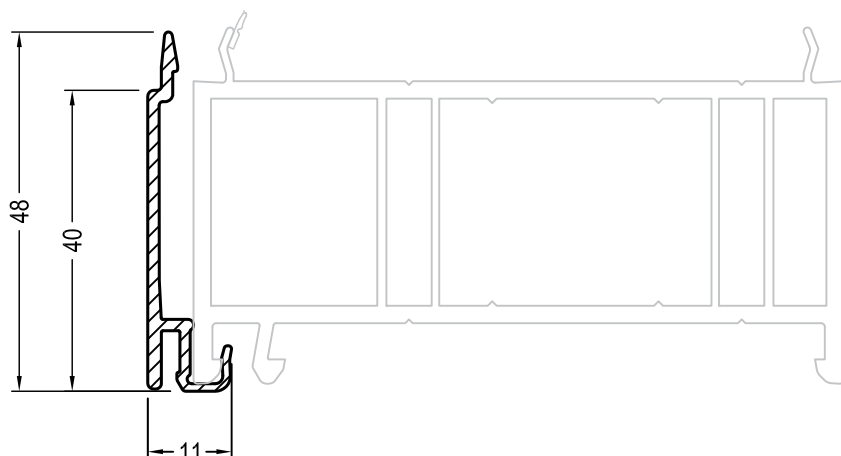

ALU TOP Blendrahmenverbreiterung 40

**1209874** 

 6

Blendrahmenverbreiterung 40/86 mit IDS

**1533005** 

 36

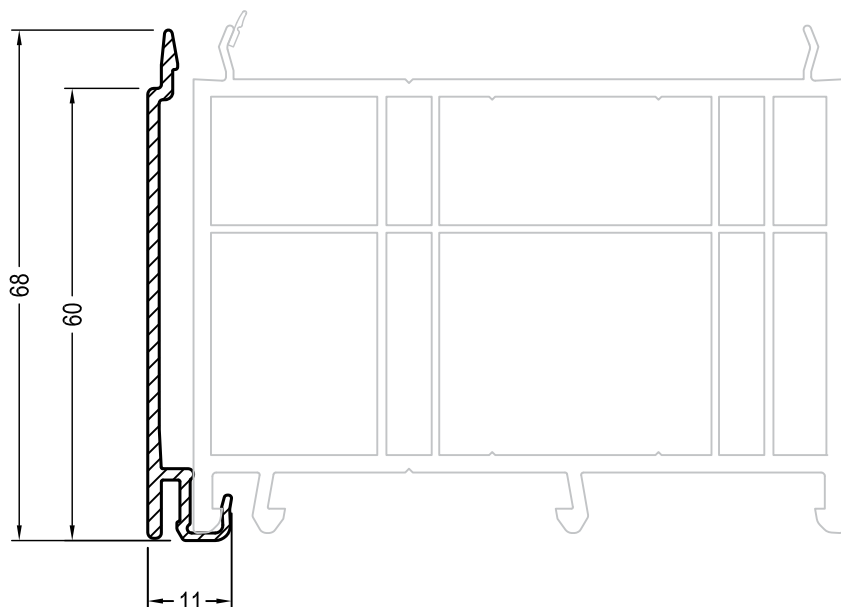

ALU TOP Blendrahmenverbreiterung 60

**1209875** 

 6

Blendrahmenverbreiterung 60/86 mit IDS

**1533165** 

 36



Lieferfähigkeit der ALU TOP Blendrahmenverbreiterungen  
vorgesehen für Juni 2013!

# ALU TOP 86

## PROFILDRUCK

### Blendrahmenverbreiterungen

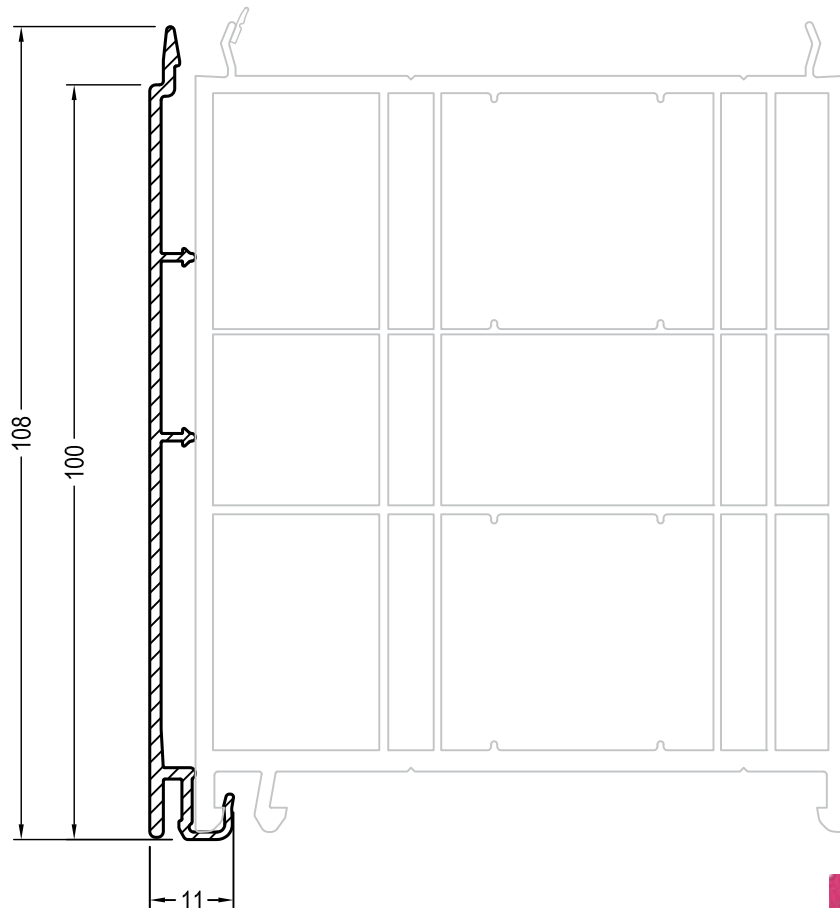

ALU TOP Blendrahmenverbreiterung 100

**1209876** 

 6

Blendrahmenverbreiterung 100/86 mit IDS

**1533015** 

 12



Lieferfähigkeit der ALU TOP Blendrahmenverbreiterungen  
vorgesehen für Juni 2013!

# ALU TOP 86

## PROFILDRUCK

### Zubehör

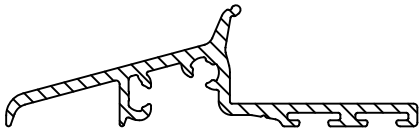

ALU TOP Wetterschenkel

1305808 

 6

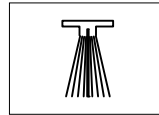

ALU TOP Bürstendichtung 10/10 für Wetterschenkel l=1,1m

 1305834

 1

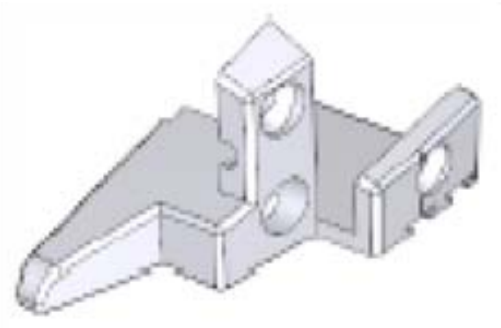

Endkappe Wetterschenkel

ASA

1305909   

 1

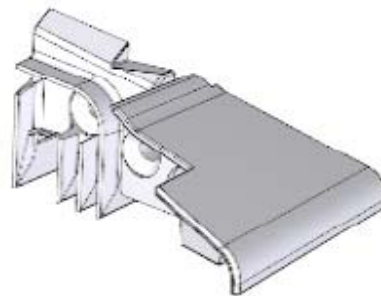

Endkappe Wetterschenkel Stulp

ASA

1305815   

 1

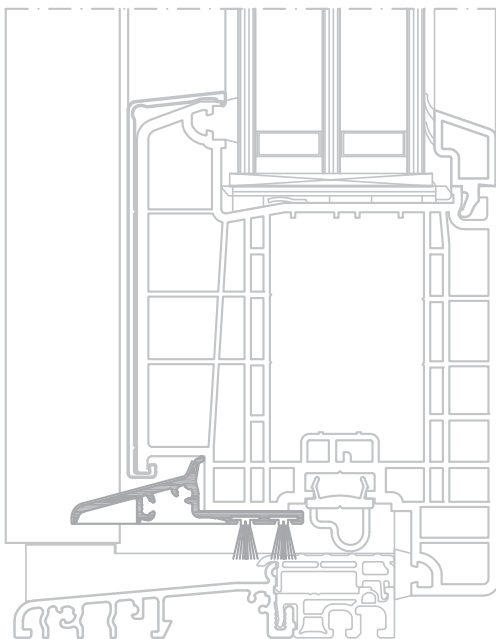

Wetterschenkel Haustür

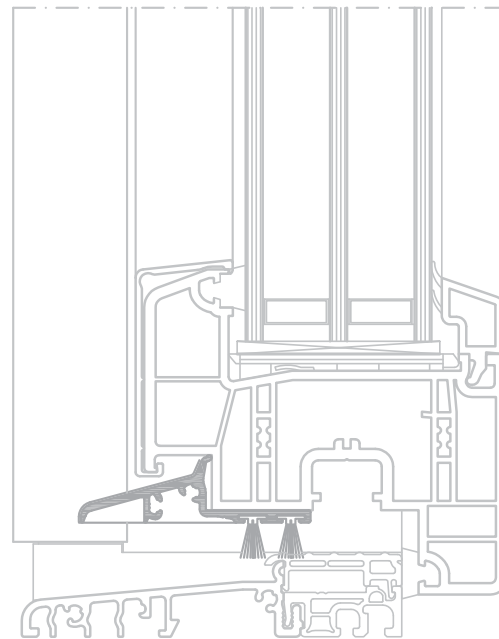

Wetterschenkel Fenstertür

# ALU TOP 86

## PROFILDRUCK

### Zubehör

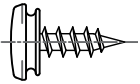

ALU TOP Montageschraube

**1305054**

Stahl verzinkt

 500



Lieferfähigkeit der ALU TOP Montageschraube 1305054  
vorgesehen für Juni 2013!



Blendrahmenanschlagdichtung EPDM

**1232881** 

 300



Verglasungsdichtung EPDM

**1232911** 

 300



Stulpdichtung

**1211023** 

 200

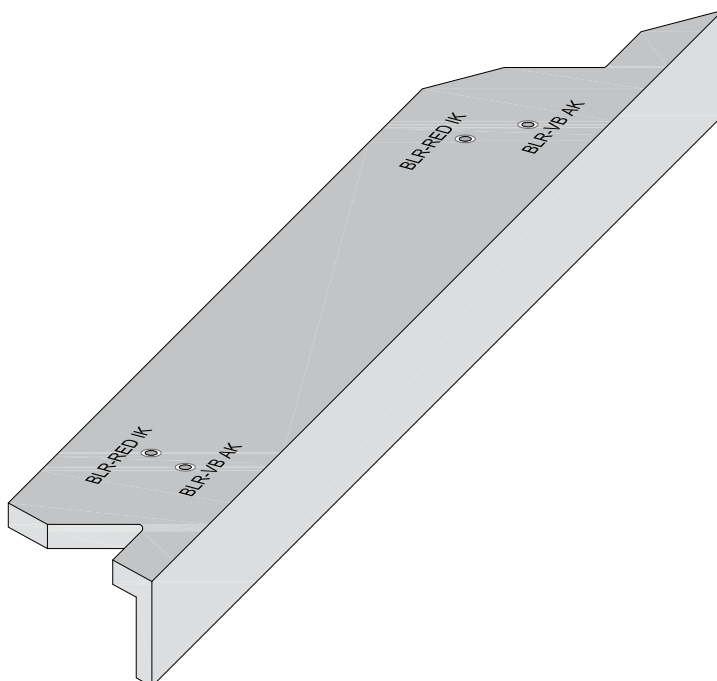

ALU TOP Bohrlehre universal

**1215251**

 1

# ALU TOP 86

## PROFILDRUCK

### Artikelverzeichnis

Art. -Nr.	Bezeichnung	Pack/ Bündel in m	Langgutpalette in m		Beutel/ Karton in Stück	Seite
			Pack	Schrumpf		
1209864	ALU TOP Blendrahmen 72 / Blendrahmen 72 GENE <sup>®</sup>	6				2
1209865	ALU TOP Blendrahmen 86 GENE <sup>®</sup>	6				3
1209866	ALU TOP Blendrahmen 90	6				4
1209867	ALU TOP Pfosten 98 GENE <sup>®</sup>	6				6
1209868	ALU TOP Pfosten 126 GENE <sup>®</sup>	6				7
1209869	ALU TOP Flügel 57 GENE <sup>®</sup>	6				10
1214478	ALU TOP Flügel 57 GENE <sup>®</sup> Stulp	6				10
1209870	ALU TOP Flügel 84 GENE <sup>®</sup>	6				11
1209872	ALU TOP Haustürflügel Z GENE <sup>®</sup>	6				14
1209871	ALU TOP Blindpfosten Bautiefe 86	6				15
1209884	ALU TOP Stulpprofil GENE <sup>®</sup>	6				16
1209873@	ALU TOP Blendrahmenverbreiterung 20	6				17
1209874	ALU TOP Blendrahmenverbreiterung 40	6				17
1209875	ALU TOP Blendrahmenverbreiterung 60	6				17
1209876	ALU TOP Blendrahmenverbreiterung 100	6				18
1209878	ALU TOP Blendrahmen 66 ED 86	6				5
1209879	ALU TOP Blendrahmen 80 ED 86	6				5
1209880	ALU TOP Pfosten 86 ED 86	6				8
1209881	ALU TOP Pfosten 112 ED 86	6				9
1209882	ALU TOP Flügel 57 ED 86	6				12
1209883	ALU TOP Flügel 84 ED 86	6				13
1211023	Stulpdichtung	200				20
1215251	ALU TOP Bohrlehre universal	1				20
1232881	Blendrahmenanschlagdichtung EPDM	300				20
1232911	Verglasungsdichtung EPDM	300				20
1305808	ALU TOP Wetterschenkel	6				19
1305834	ALU TOP Bürstendichtung 10/10 für Wetterschenkel				1	19
1305909	Endkappe Wetterschenkel				1	19
1305815	Endkappe Wetterschenkel Stulp				1	19
1305054	ALU TOP Montageschraube				500	20
1305659	ALU TOP Endkappe Stulpprofil außen GENE <sup>®</sup>	1			1	16
1305663	ALU TOP Endkappe Blindpfosten außen Bautiefe 86	1			1	15
1355265	Endkappe Stulpprofil innen rechts				50	16
1355275	Endkappe Stulpprofil innen links				50	16
1355285	Endkappe Blindpfosten innen GENE <sup>®</sup> rechts				50	15
1355295	Endkappe Blindpfosten innen GENE <sup>®</sup> links				50	15
1532010	Blendrahmen 72 GENE <sup>®</sup>	24				2
1532036	Flügel 57 GENE <sup>®</sup>	24				10
1532050	Pfosten 98 GENE <sup>®</sup>	24				6
1532075	Stulpprofil GENE <sup>®</sup>	24				16
1532080	Blindpfosten Bautiefe 86	24				15

# ALU TOP 86

## PROFILDRUCK































### Artikelverzeichnis

Art. -Nr.	Bezeichnung	Pack/ Bündel in m	Langgutpalette in m		Beutel/ Karton in Stück	Seite
			Pack	Schrumpf		
1532136	Flügel 84 GENEEO®	12				11
1532166	Haustürflügel Z GENEEO®	13				14
1532300	Blendrahmen 86 GENEEO®	24				3
1532345	Pfosten 126 GENEEO®	24				7
1532400	Blendrahmen 72	24				2
1532450	Blendrahmen 90	24				4
1532500	Blendrahmen 66 ED 86	24				5
1532510	Blendrahmen 80 ED 86	24				5
1532575	Pfosten 86 ED 86 m.D.	24				8
1532605	Pfosten 112 ED 86 m.D.	12				9
1532526	Flügel Z 57 ED 86	24				12
1532546	Flügel Z 84 ED 86	24				13
1533005	Blendrahmenverbreiterung 40/86 mit IDS	36				17
1533015	Blendrahmenverbreiterung 100/86 mit IDS	12				18
1533125	Blendrahmenverbreiterung 20/86 mit IDS	36				17
1533165	Blendrahmenverbreiterung 60/86 mit IDS	36				17

# ALU TOP 86

## PROFILDRUCK

### Zeichenerklärung



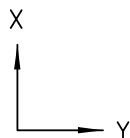









	Farbe Schwarz
	Farbe Grau
	Farbe Weiß
	Farbe Cremeweiß
	Farbe Braun
	Farbe Karamell
	Farbe Grün
	Farbe Rot
	Farbe Silber
	Farbe beliebig
	Aluminium natur eloxiert
	Aluminium pressblank
	Kaschierte Ausführung
	Lackierte Ausführung
	Verpackungseinheit (Details siehe Artikelverzeichnis)
	Wanddicke in mm
	Mit verschweißbarer Dichtung
	Mit nicht verschweißbarer Dichtung
	Manuell einzuziehende Dichtung
	Rechte Ausführung
	Linke Ausführung
@	Außerstandard, Lieferzeit auf Anfrage
lx	Trägheitsmoment in X-Richtung in cm <sup>4</sup> bezogen auf E-Modul von Stahl
ly	Trägheitsmoment in Y-Richtung in cm <sup>4</sup> bezogen auf E-Modul von Stahl
	Mit PVC-Kleber verkleben, weiße Profile mit Kleber 251660/251670, kaschierte Profile mit lösemittelfreien Klebstoff (z.B. Cosmofen 515, Fa. Weiss).
	Mit Silikon abdichten
	Mit EPDM-Dichtmasse abdichten
	Mit EPDM-Kleber verkleben
	Linsenkopf-Blechschaube ISO 7049
	Senkkopf-Blechschaube ISO 7050
	Senkkopf-Bohrschraube ISO 15482
	Linsenkopf-Bohrschraube ISO 15481
	Bohrlehre



1. Stelle	Verpackungsart
6	Schlauch-Holzrahmenverschlag (HRV)
7	Schlauch-Langgutpalette (LGP)
8	Schrumpf-Holzrahmenverschlag (HRV)
9	Schrumpf-Langgutpalette (LGP)

2. und 3. Stelle	Farbnummern	
	Profil	Profil/Dichtung
01	Weiß 159	Weiß/Schwarz 159/601
05	-	Weiß/Weiß 159/159
15	-	Weiß/Grau 159/RAL 7001

Beispiele:

XXXXXX 	- Art. in Weiß ohne Dichtung - Var. X01, kleinste Verpackungseinheit 36 m
 36	
XXXXXX  	- Art. in Weiß mit weißer Dichtung - Var. X05, kleinste Verpackungseinheit 24 m
 24	
XXXXXX  	- Art. in Weiß mit grauer Dichtung - Var. X15, kleinste Verpackungseinheit 36 m
 36	
XXXXXX  	- Art. kaschiert mit schwarzer Dichtung - diverse Varianten z.B. gem. Standardfarb-
 24	 <i>tableau</i> , kleinste Verpackungseinheit 24 m

 Achtung: Nicht alle Profile werden in allen oben gelisteten Varianten angeboten.

### Artikelsystematik in SAP

Mit der Umstellung auf SAP ändern sich die Artikelnummern. Die neuen Artikelnummern sind nun 7-stellig, bestehend aus den vorhandenen 6-stelligen Artikelnummern mit einer „1“ davor. z.B. lautet die vorhandene Artikelnummer 550460 in SAP: 1550460.

### Variantensystematik in SAP

Mit der Umstellung auf SAP ändern sich die Variantenummern. Die neuen Variantenummern sind nun 4-stellig, bestehend aus den vorhandenen 3-stelligen Variantenummern mit einer „1“ davor. z.B. lautet die vorhandene Variantenummer 720 in SAP: 1720.

### Variantensystematik

Nach der Artikelnummer (z.B. 550460) folgt eine 3-stellige Variante (z.B. 701), die bei Haupt- und Zusatzprofilen gleichermaßen aufgebaut ist.

Die Variante besteht aus jeweils 3 Stellen.

1. Stelle steht für *Verpackungsart*

2. und 3. Stelle stehen für *Farbnummern*

### Materialnummer

Mit der Umstellung auf SAP werden die nun 7-stelligen Artikelnummern (siehe Artikelsystematik in SAP) und 4-stelligen Variantenummern (siehe Variantensystematik in SAP) zu einer 11-stelligen Materialnummer zusammengefaßt, z.B. 15504601720.



---

Unsere anwendungstechnische Beratung erfolgt nach bestem Wissen, gilt jedoch als unverbindlicher Hinweis. Wir empfehlen daher zu prüfen, ob die in dieser Druckschrift genannten Angaben für Ihre vorgesehene technische Lösung geeignet sind.

Anwendung, Verwendung und Verarbeitung unserer Produkte erfolgen außerhalb unserer Kontrollmöglichkeiten und liegen daher ausschließlich in Ihrem Verantwortungsbereich. Unsere Gewährleistung bezieht sich daher in jedem Fall auf die

gleichbleibende Qualität unserer Produkte entsprechend unserer Spezifikation. Sollte eine Haftung in Frage kommen, so richtet sich diese nach unseren Ihnen bekannten allgemeinen Lieferungs- und Zahlungsbedingungen. Diese sind auch abrufbar unter <http://rehau.de/lzb> oder werden auf Anfrage zugesandt. Für Schäden, die aus der Verwendung von anderen als in unseren Unterlagen aufgeführten Original-System-Zubehörteilen herrühren, ist jede Gewährleistung und Haftung von REHAU ausgeschlossen.