

SYNEGO[®]

TECHNISCHE INFORMATION

PROFILDRUCK

Inhaltsverzeichnis

Blendrahmen AD	2
Pfosten-Kämpfer AD	4
Blendrahmen MD	6
Pfosten-Kämpfer MD	9
Flügel	11
Flügelsprossen	17
Profile für mehrflügelige Fenster ohne festen Pfosten	18
Zubehör für mechanische Verbindungen	22
Zubehör für mechanische Verbindungen	23
Bodenschwelle und Zubehör	25
Zubehör auswärts öffnende Elemente	29
Zubehör für Haus- und Nebeneingangstüren	30
Bohrlehren	31
Armierungen	32
Artikelverzeichnis	40
Zeichenerklärung	44
Variantensystematik	45
Tableau Standardfarben	a

Blendrahmen AD

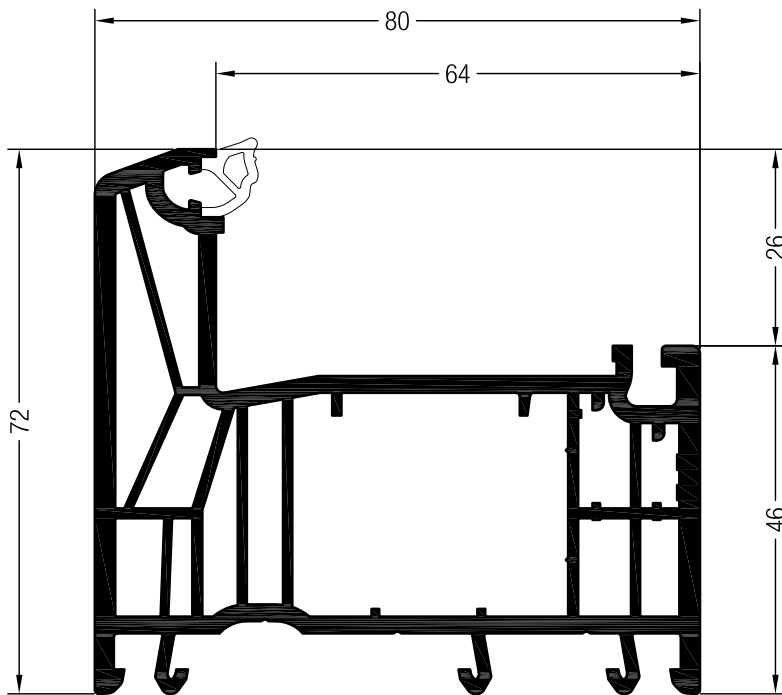

Blendrahmen 72 AD SYNEGO®

- 1537005**
-
- 1567005**
- 24

Blendrahmen 72 AD SYNEGO® für Alu-Vorsatzschale (ohne Universaldichtung)

- 1537000**
- 24

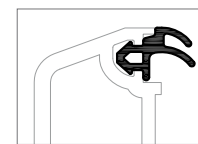

	1232881
	1232871

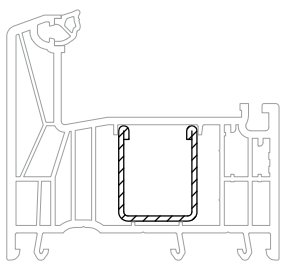

23 x 28

	1306619
	1,5
lx	1,1
ly	1,1
	6

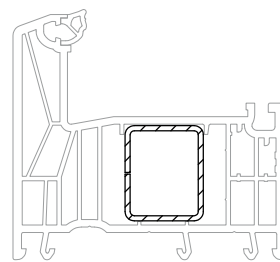

23 x 28

	1357540
	1,5
lx	1,1
ly	1,5
	6

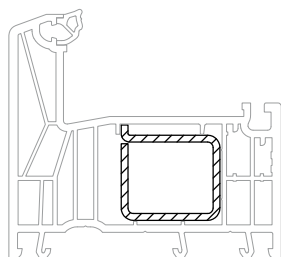

29 x 28

	1357550
	2
lx	2,3
ly	1,8
	6

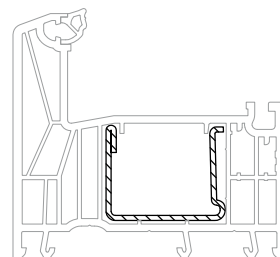

35 x 28

	1244516	1244526
	1,5	2
lx	2,7	3,5
ly	1,3	1,7
	6	6

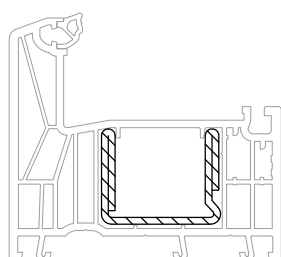

35 x 28

	1244536
	2
lx	5
ly	2
	6

Blendrahmen AD

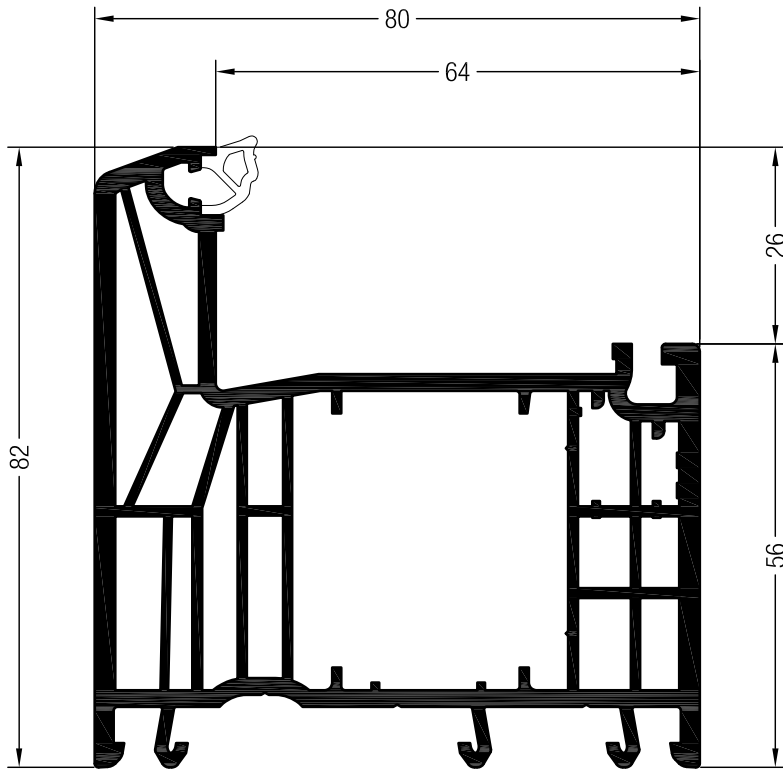

Blendrahmen 82 AD SYNEGO®

- 1537015**

- 1567015**
- 24

Blendrahmen 82 AD SYNEGO® für Alu-Vorsatzschale (ohne Universaldichtung)

- 1537010**
- 24

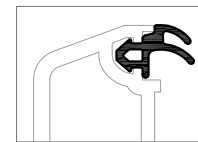

	1232881
	1232871

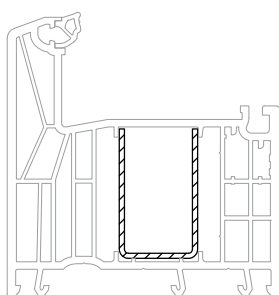

23 x 38

	1357541
	1,5
lx	1,4
ly	2,1
	6

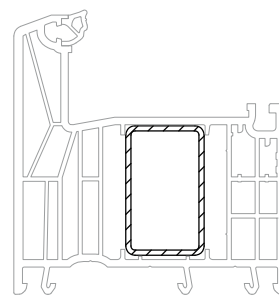

23 x 38

	1357542
	1,5
lx	1,5
ly	3,2
	6

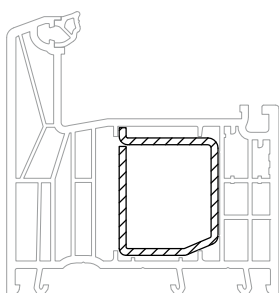

29 x 37,5

	1357559
	2
lx	2,9
ly	3,9
	6

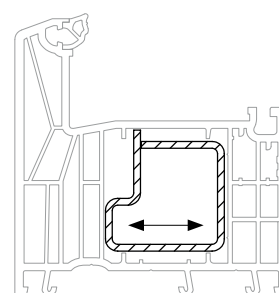

35 x 36

	1357543
	2
lx	3,6
ly	3,7
	6

Pfosten-Kämpfer AD

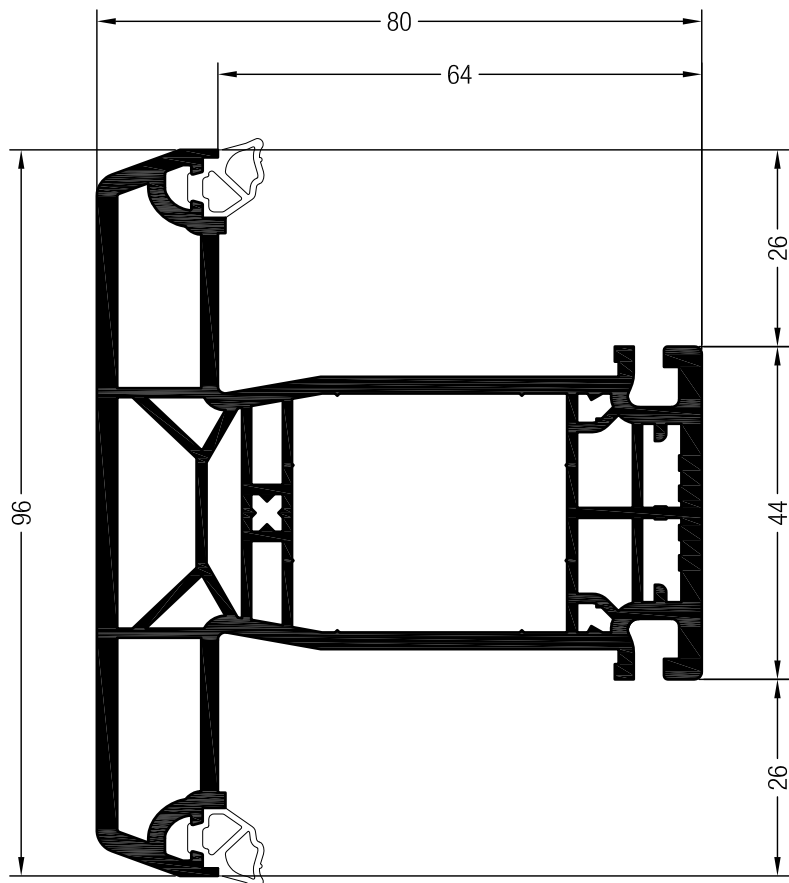

Pfosten 96 AD SYNEGO®

1537405  

   @

   @

1567405  

 24



Pfosten 96 AD SYNEGO® für Alu-Vorsatzschale (ohne Universaldichtungen)

1537400 

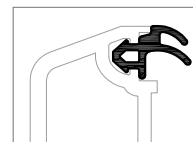
 24



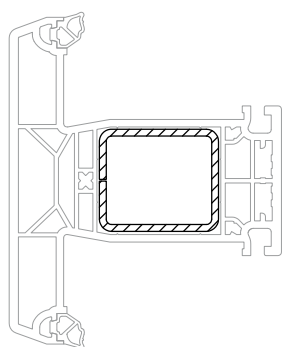

 E

	1232881
	1232871



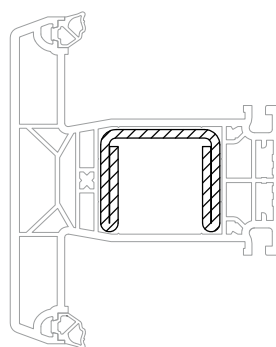

35 x 30

	1357544
	2
lx	4
ly	3,1
	6



35 x 30

	1357551
	2,5
lx	6,6
ly	2,9
	6

Pfosten-Kämpfer AD

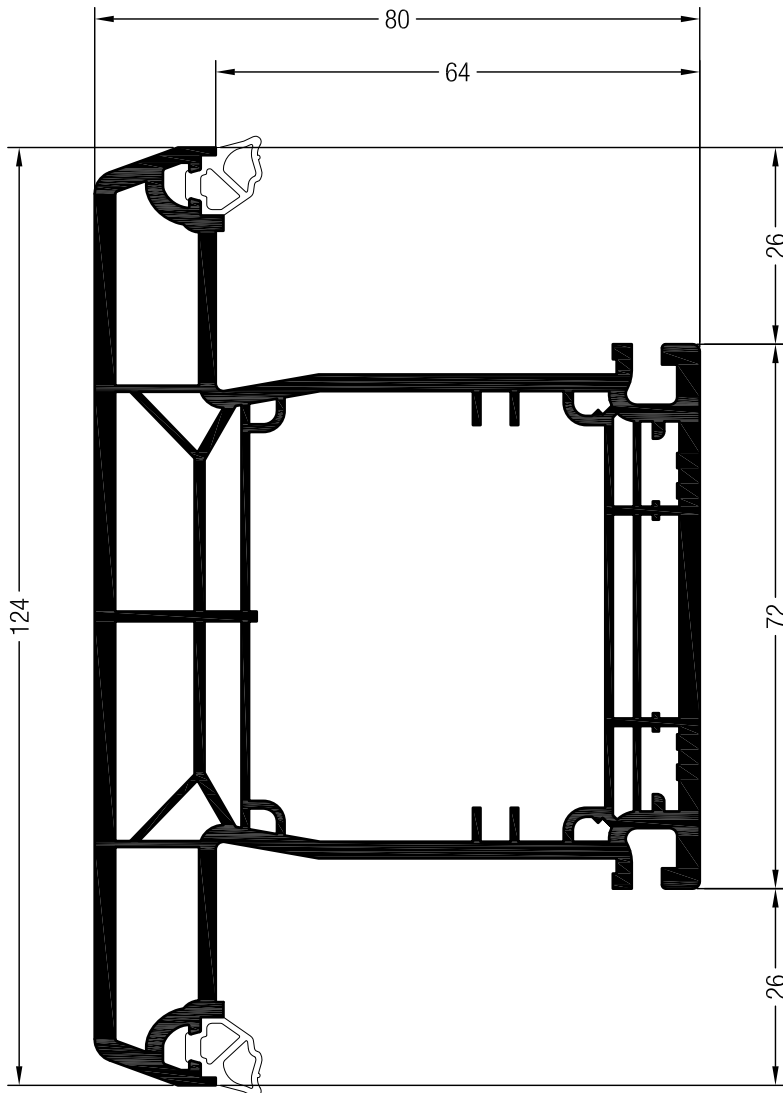

Pfosten 124 AD SYNEGO®

- 1537415**
-
- 1567415**

12

Pfosten 124 AD SYNEGO® für Alu-Vorsatzschale (ohne Universaldichtungen)

1537410

12

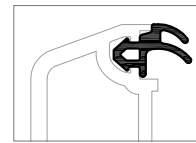

	1232881
	1232871

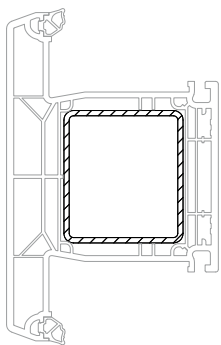

45 x 50

	1357545
	2
lx	11,1
ly	13,1
	6

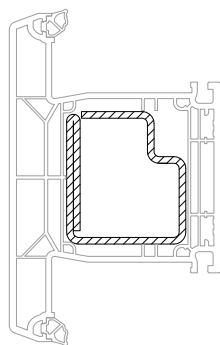

45 x 50

	1357546
	2,5
lx	14,1
ly	15,4
	6

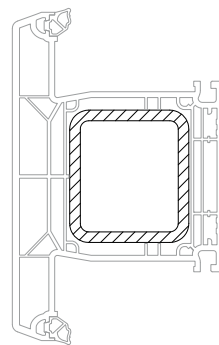

45 x 50

	1357553@
	4
lx	18,6
ly	22
	6

Blendrahmen MD

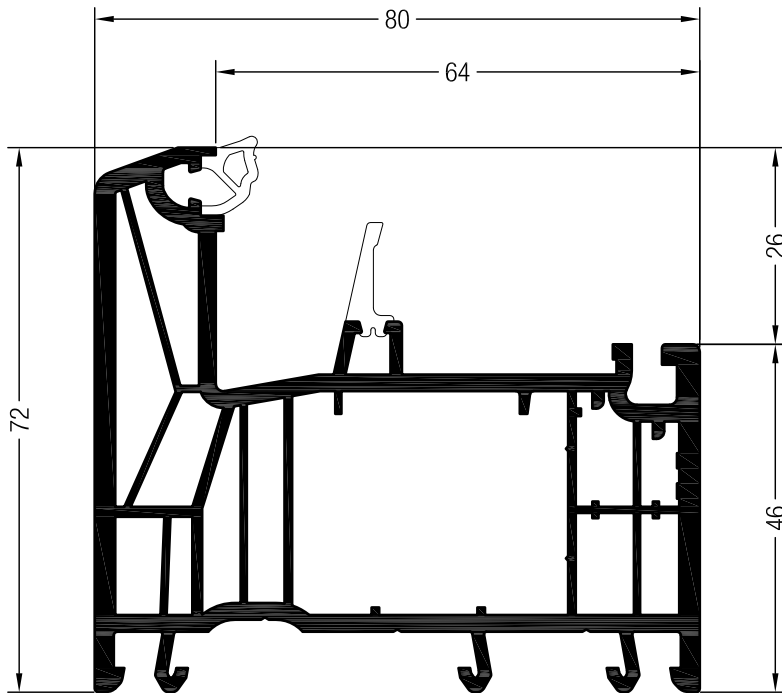

Blendrahmen 72 MD SYNEGO®

- 1537105**
- @
- @
- 1567105**
- 24

Blendrahmen 72 MD SYNEGO® für Alu-Vorsatzschale (ohne Universaldichtung)

- 1537100**
- 24

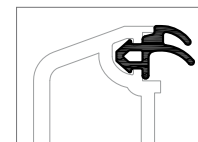

	E
	1232881
	1232871

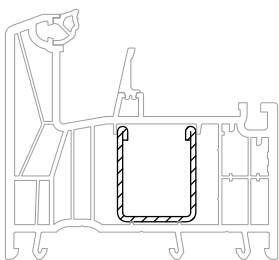

23 x 28

	1306619
	1,5
lx	1,1
ly	1,1
	6

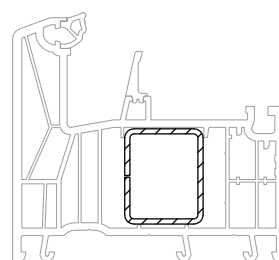

23 x 28

	1357540
	1,5
lx	1,1
ly	1,5
	6

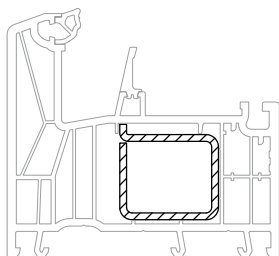

29 x 28

	1357550
	2
lx	2,3
ly	1,8
	6

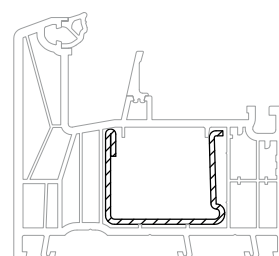

35 x 28

	1244516	1244526
	1,5	2
lx	2,7	3,5
ly	1,3	1,7
	6	6

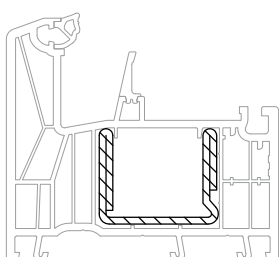

35 x 28

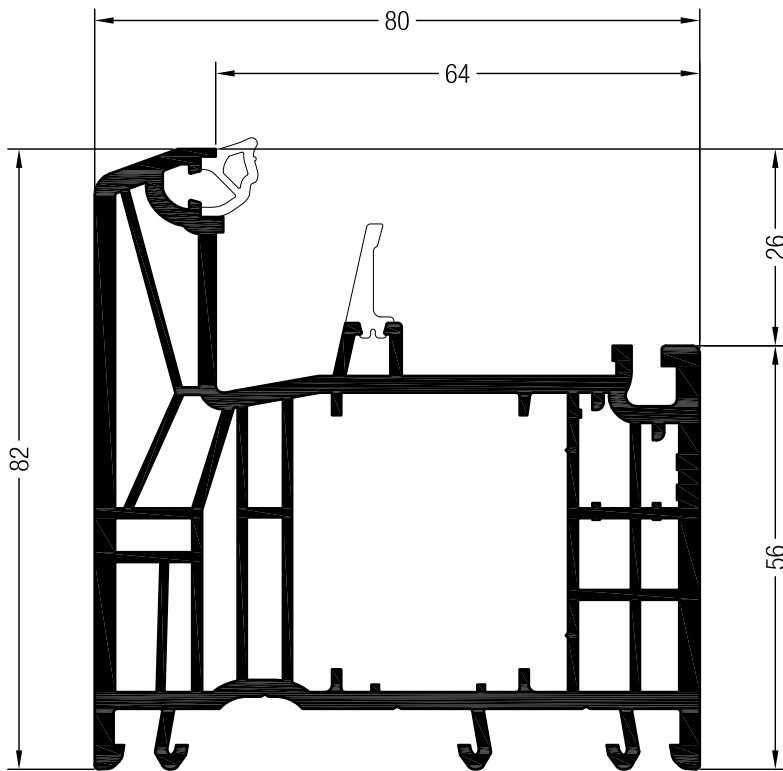

	1244536
	2
lx	5
ly	2
	6

Blendrahmen MD





Blendrahmen 82 MD SYNEGO®

1537115   
  @
   @

1567115  

 24

Blendrahmen 82 MD SYNEGO® für Alu-Vorsatzschale (ohne Universaldichtung)

1537110  

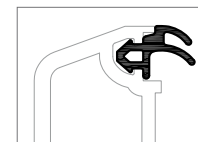

 24

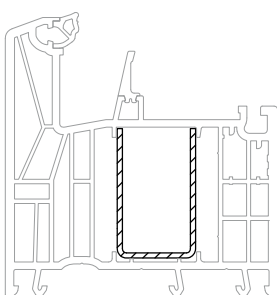

	1232881
	1232871



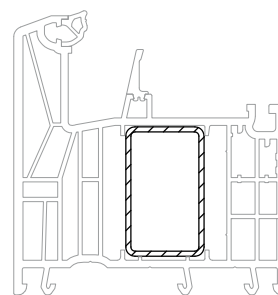

23 x 38

	1357541
	1,5
lx	1,4
ly	2,1
	6



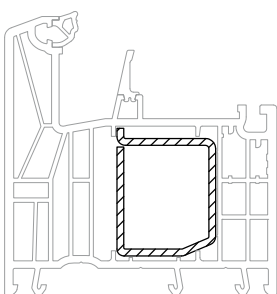

23 x 38

	1357542
	1,5
lx	1,5
ly	3,2
	6



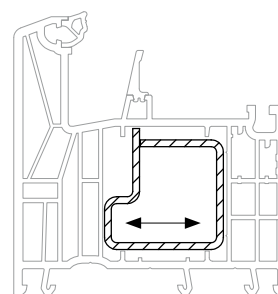

29 x 37,5

	1357559
	2
lx	2,9
ly	3,9
	6



35 x 36

	1357543
	2
lx	3,6
ly	3,7
	6

Blendrahmen MD

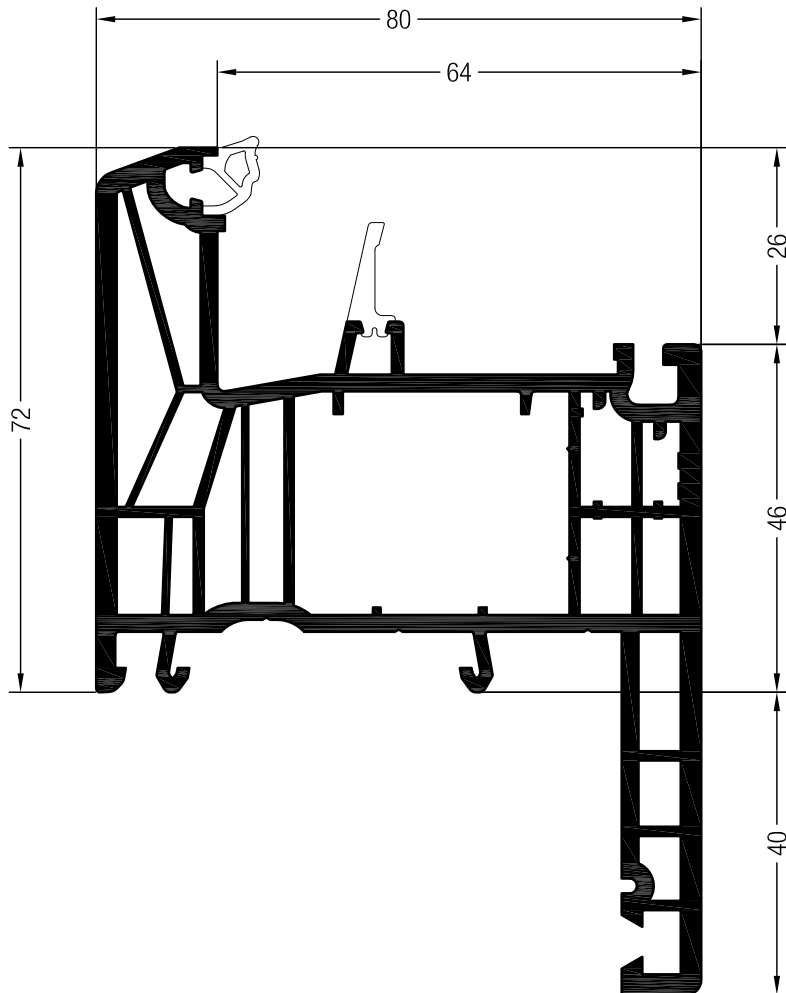

Blendrahmen 72/40 MD SYNEGO®

- 1537165
- @
- @
- 1567165 @
- 24

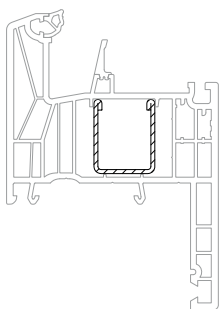

23 x 28

	1306619
	1,5
lx	1,1
ly	1,1
	6

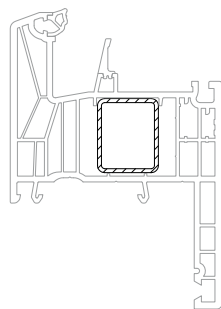

23 x 28

	1357540
	1,5
lx	1,1
ly	1,5
	6

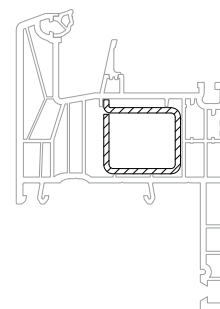

35 x 25

	1357550
	2
lx	2,3
ly	1,8
	6

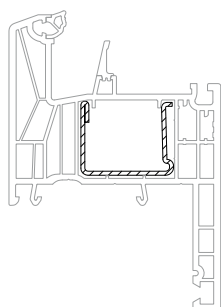

35 x 28

	1244516	1244526
	1,5	2
lx	2,7	3,5
ly	1,3	1,7
	6	6

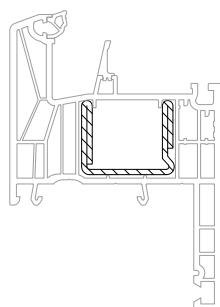

35 x 28

	1244536
	2
lx	5
ly	2
	6

Pfosten-Kämpfer MD

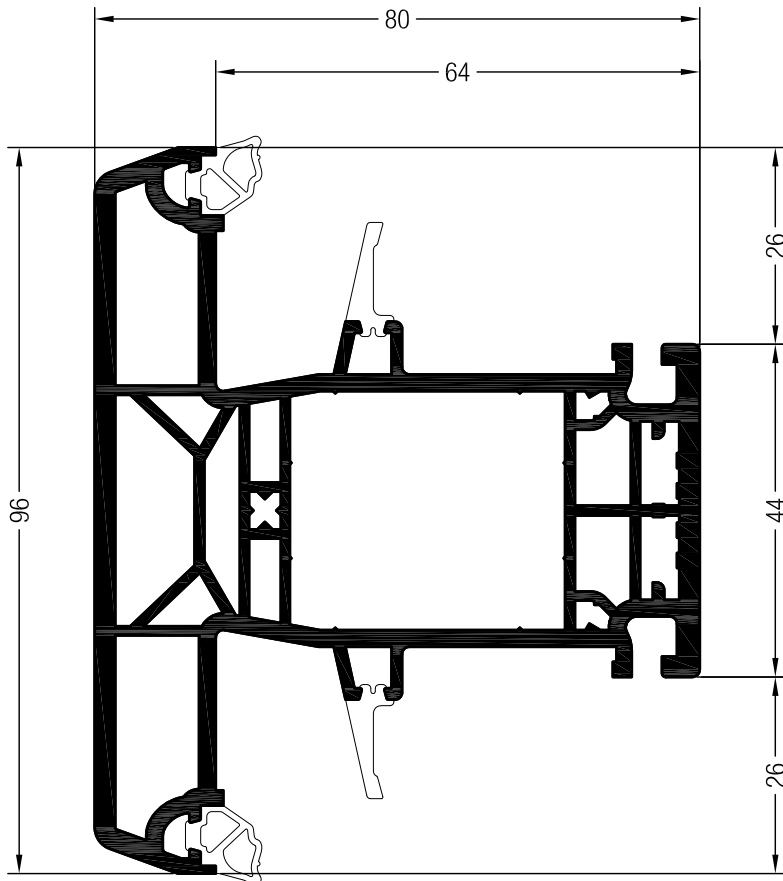

Pfosten 96 MD SYNEGO®

- 1537505**
-
-

- 1567505**
- 24

Pfosten 96 MD SYNEGO® für Alu-Vorsatzschale (ohne Universaldichtungen)

- 1537500**
- 24

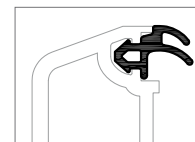

	1232881
	1232871

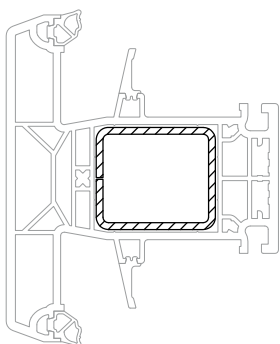

35 x 30

	1357544
	2
lx	4
ly	3,1
	6

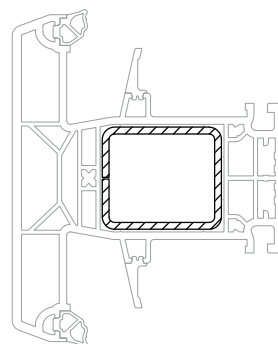

35 x 30

	1357551
	2,5
lx	6,6
ly	2,9
	6

Pfosten-Kämpfer MD

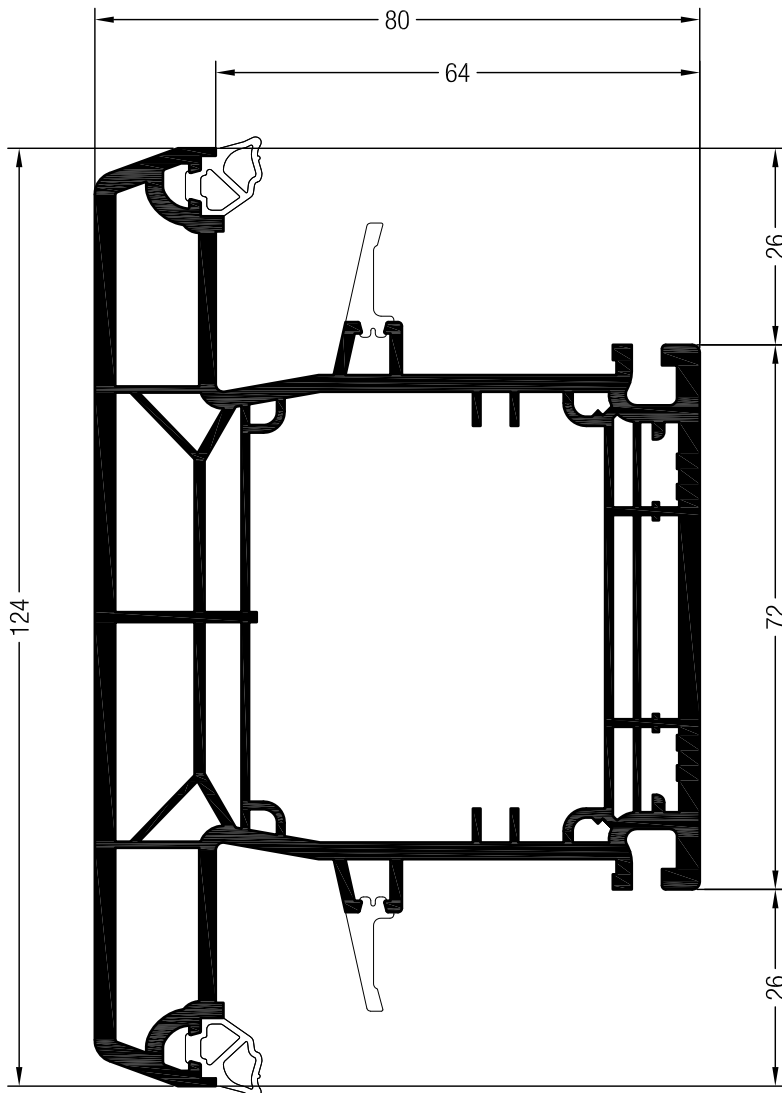

Pfosten 124 MD SYNEGO®

- 1537515**

- 1567515**
- 12

Pfosten 124 MD SYNEGO® für Alu-Vorsatzschale (ohne Universaldichtungen)

- 1537510**
- 12

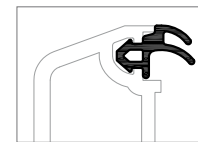

	1232881
	1232871

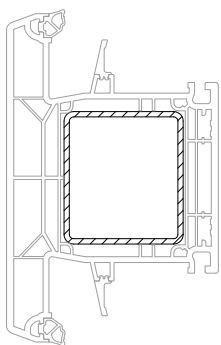

45 x 50

	1357545
	2
lx	11,1
ly	13,1
	6

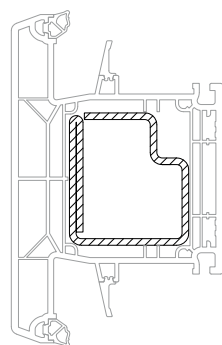

45 x 50

	1357546
	2,5
lx	14,1
ly	15,4
	6

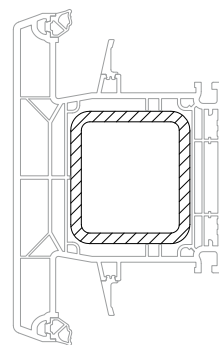

45 x 50

	1357553@
	4
lx	18,6
ly	22
	6

Flügel

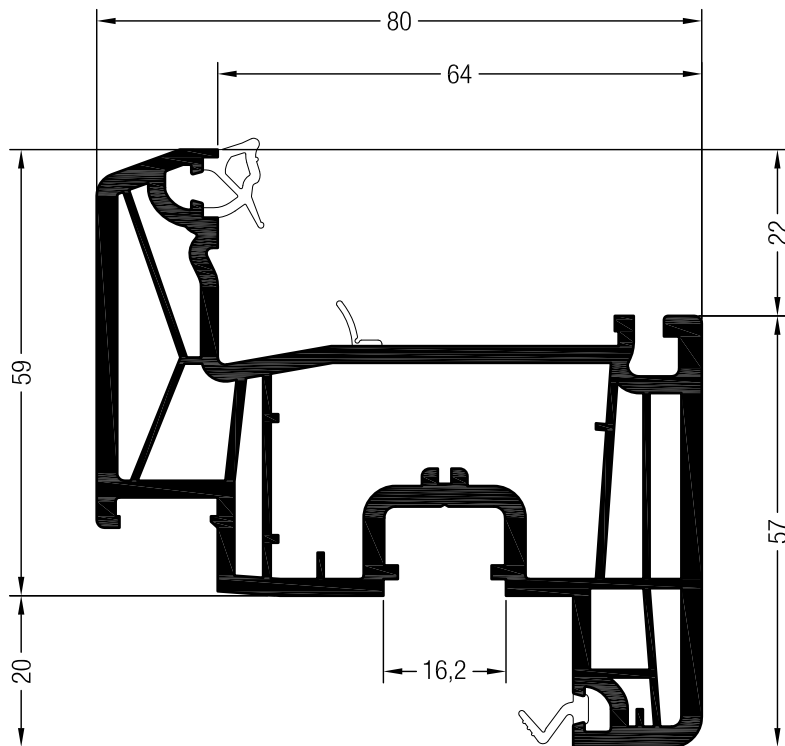

Flügel Z 59 SYNEGO®

- 1537215
- @
- @
- 1567215
- 24

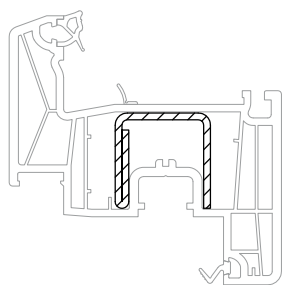

28 x 28

	1313130
	2
lx	2,5
ly	1,6
	6

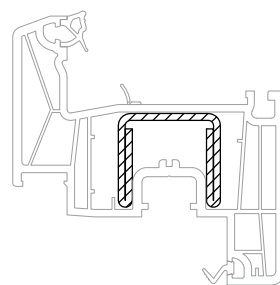

30 x 28

	1306617
	2
lx	3,7
ly	1,9
	6

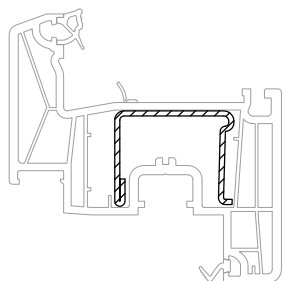

35 x 28

	1244516	1244526
	1,5	2
lx	2,7	3,5
ly	1,3	1,7
	6	6

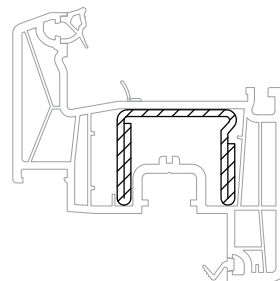

35 x 28

	1244536
	2
lx	5
ly	2
	6

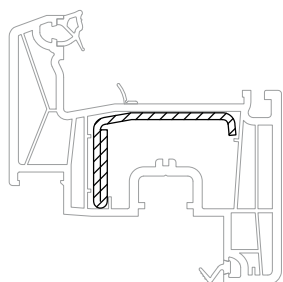

41,8 x 28

	1352515
	2
lx	3,3
ly	1,4
	6

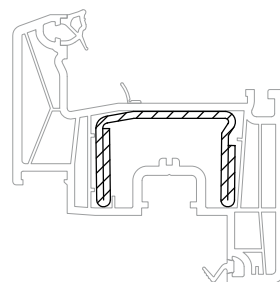

41 x 28

	1352512
	2
lx	7,1
ly	2,1
	6

Flügel

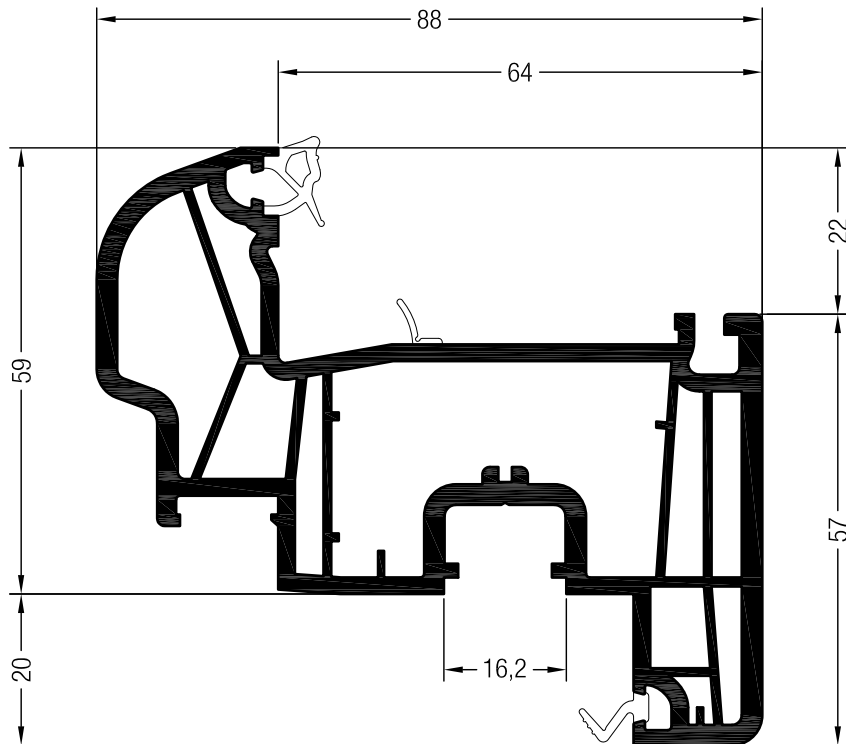

Flügel 59 rund SYNEGO®

- 1537245
- @
- 1567245 @
- 24

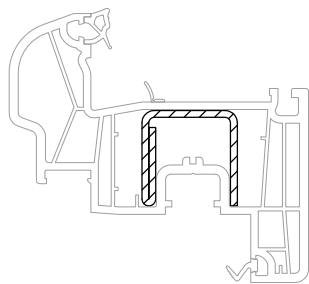

28 x 28

	1313130
	2
lx	2,5
ly	1,6
	6

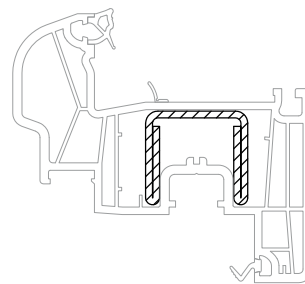

30 x 28

	1306617
	2
lx	3,7
ly	1,9
	6

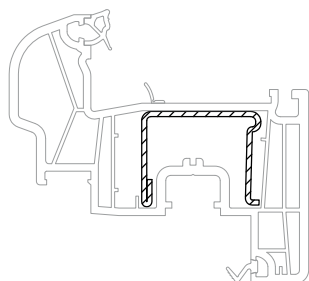

35 x 28

	1244516	1244526
	1,5	2
lx	2,7	3,5
ly	1,3	1,7
	6	6

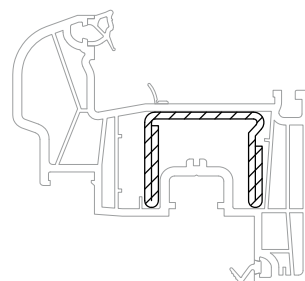

35 x 28

	1244536
	2
lx	5
ly	2
	6

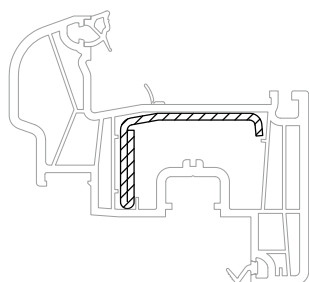

41,8 x 28

	1352515
	2
lx	3,3
ly	1,4
	6

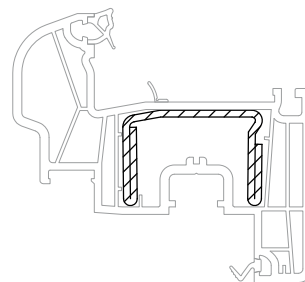

41 x 28

	1352512
	2
lx	7,1
ly	2,1
	6

Flügel

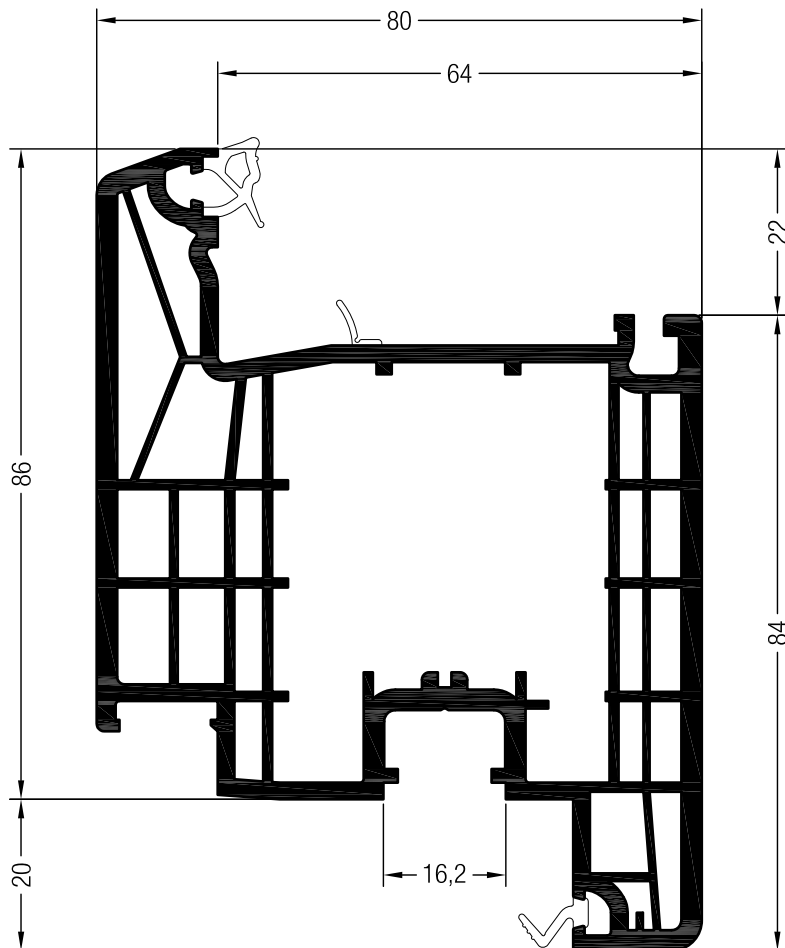

Flügel Z 86 SYNEGO®

- 1537235
- @
- @
- 1567235
- 24

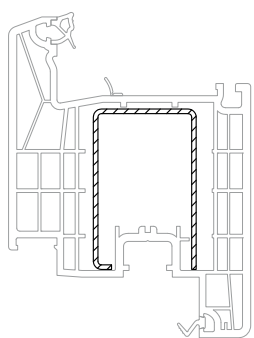

34 x 53

	1357547
	1,5
lx	4,6
ly	6,5
	6

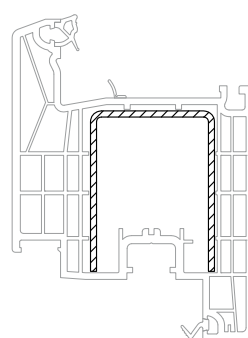

41 x 53

	1357548
	2
lx	8,7
ly	8,4
	6

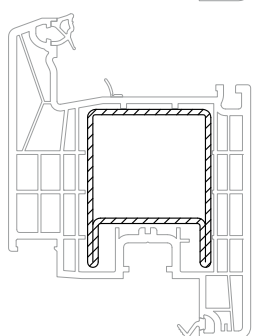

41 x 52

	1357597
	1,75
lx	9,7
ly	10,5
	6

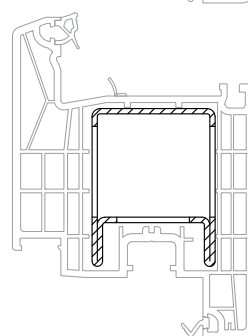

41 x 52

	1357598
	1,75
konfektioniert für Schlossseite	
	2,2

Flügel

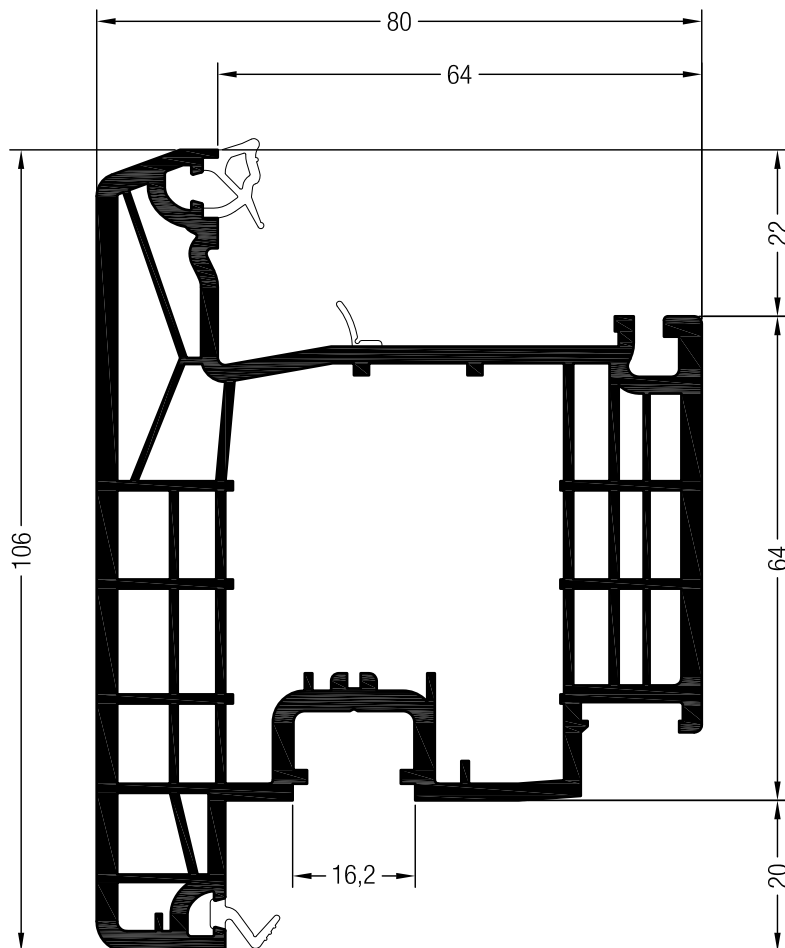

Flügel T 106 SYNEGO®

- 1537315
- @
- @
- 1567315
- 12

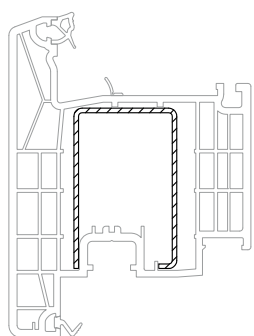

34 x 53

	1357547
	1,5
lx	4,6
ly	6,5
	6

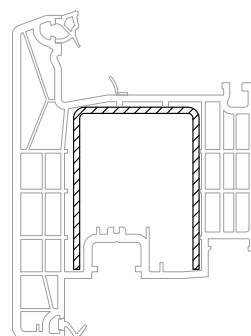

41 x 53

	1357548
	2
lx	8,7
ly	8,4
	6

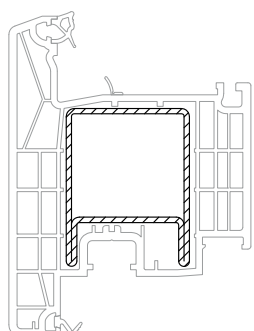

41 x 52

	1357597
	1,75
lx	9,7
ly	10,5
	6

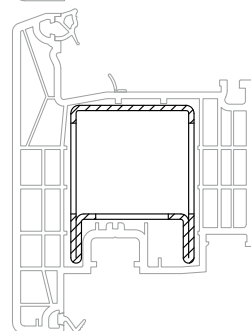

41 x 52

	1357598
	1,75
konfektioniert für Schlossseite	
	2,2

Flügel

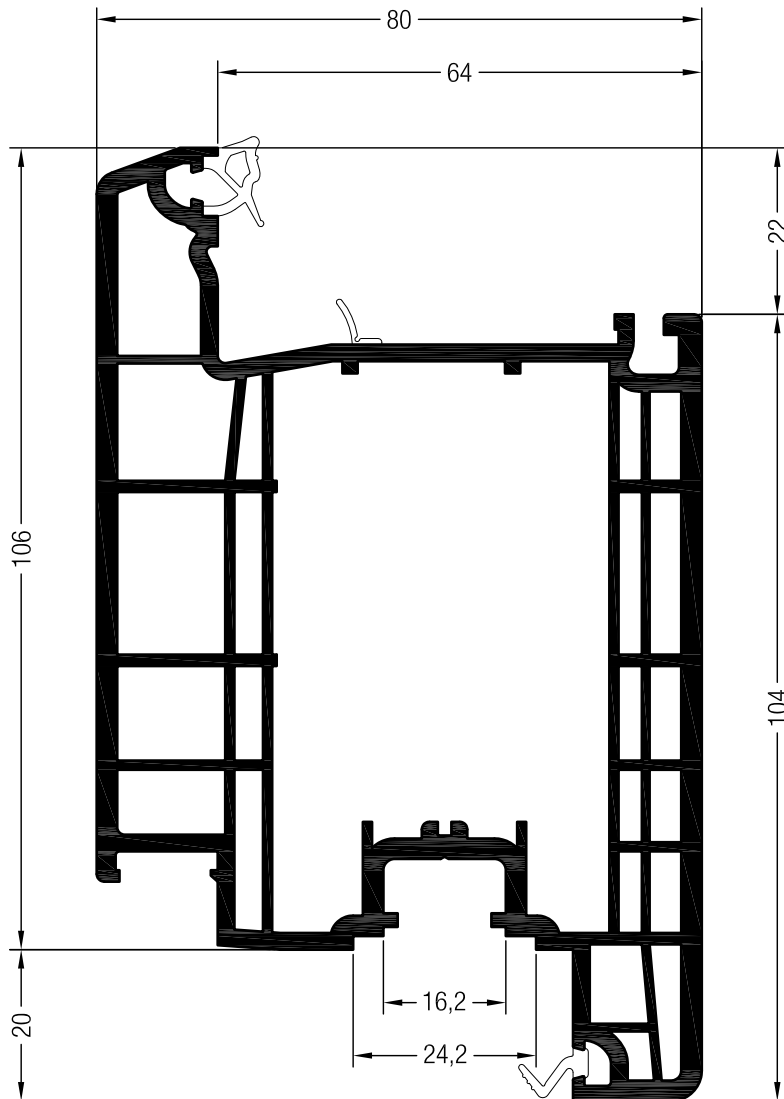

Haustürflügel Z SYNEGO®

- 1537295
- @
- @
- 1567295
- 13

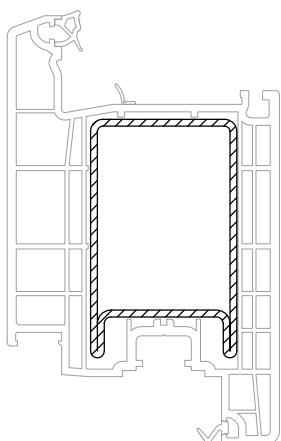

43 x 70

	1357549
	2
lx	14,9
ly	27,1
	6

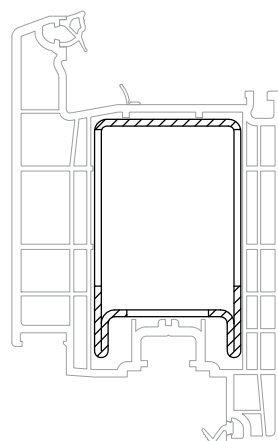

43 x 70

	1357556
	2
konfektioniert für Schlosseite	
	2,4

Flügel

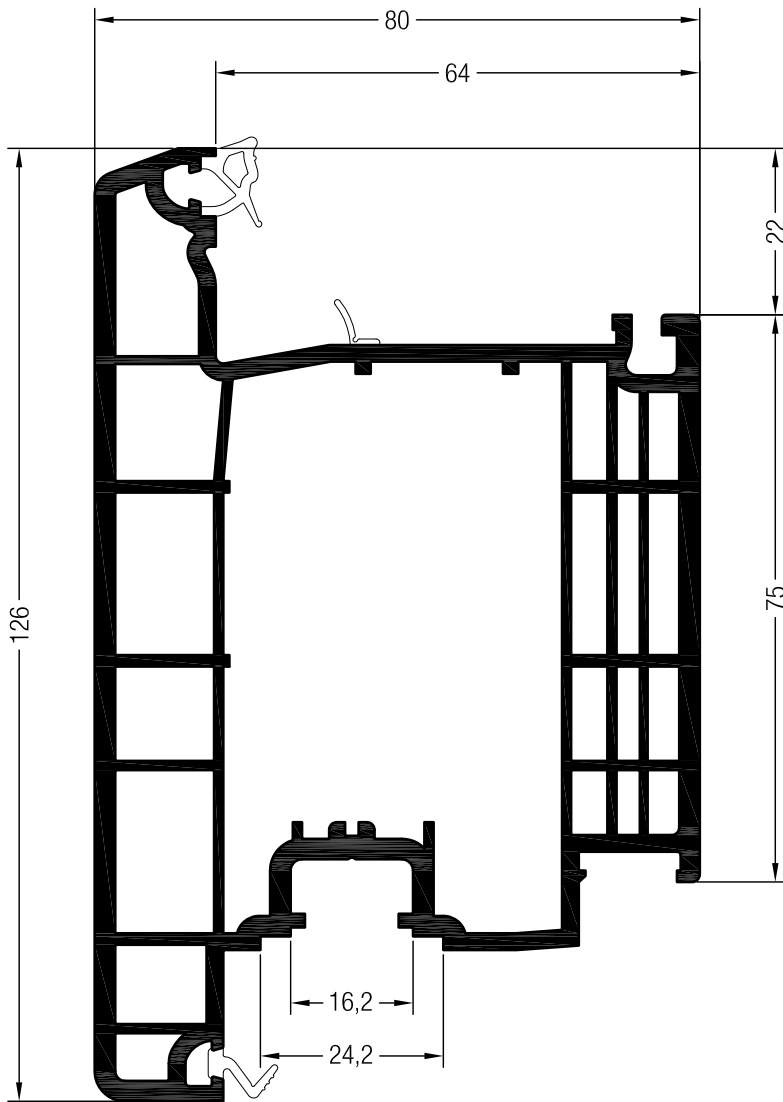

Haustürflügel T SYNEGO®

- 1537305
- 1567305
- 13

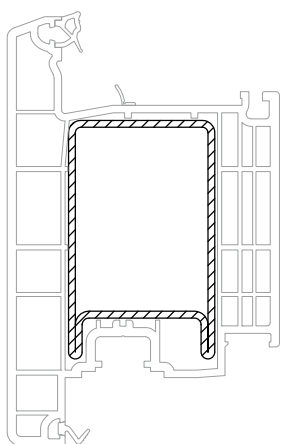

43 x 70

	1357549
	2
lx	14,9
ly	27,1
	6

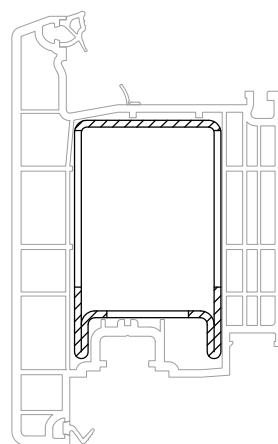







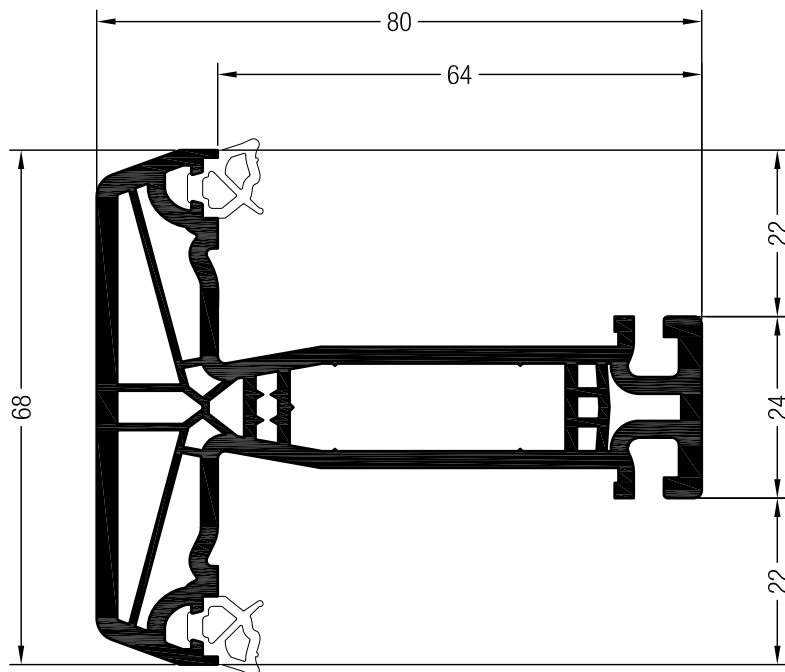





43 x 70

	1357556
	2
konfektioniert für Schlossseite	
	2,4

Flügelprossen



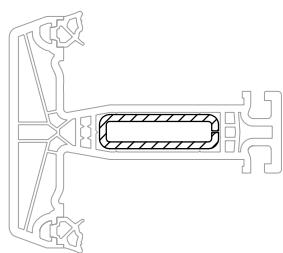

Sprosse 68 SYNEGO®

- 1537425   
-    @
-    @
- 1567425   
-  36



35 x 10

	1261801
	2
lx	1,8
ly	0,22
	6

Profile für mehrflügelige Fenster ohne festen Pfosten

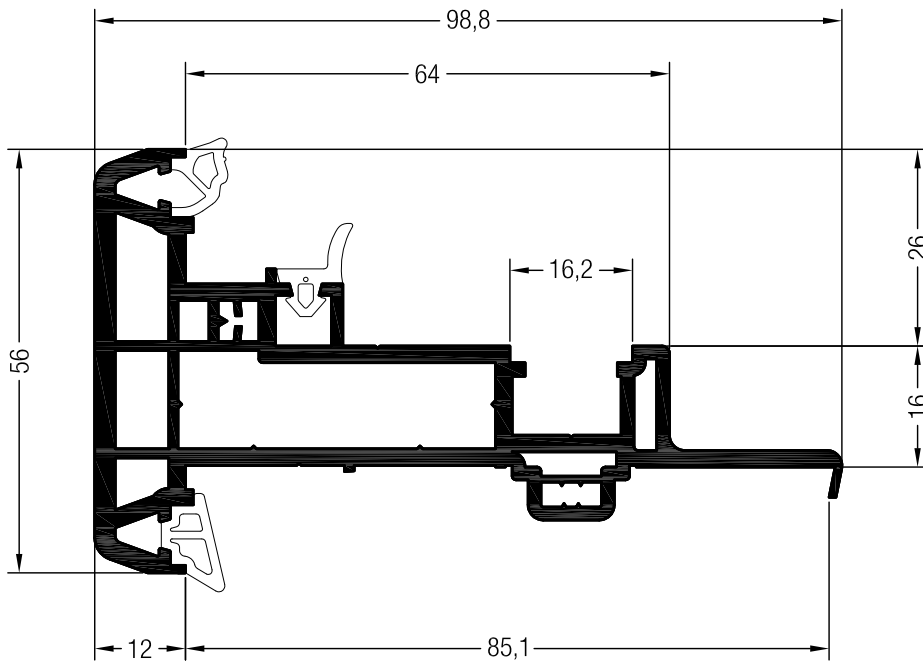

Stulpprofil SYNEGO®

1537445



1567445

24

Stulpprofil SYNEGO® für Alu-Vorsatzschale (ohne Universal- und Stulpdichtung)

1537440

24

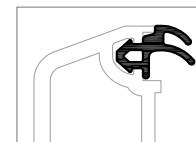

	1232881
	1232871

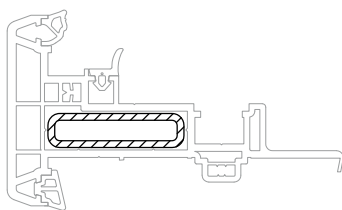

40 x 10

	1247898
	2
lx	2,7
ly	0,25
	6

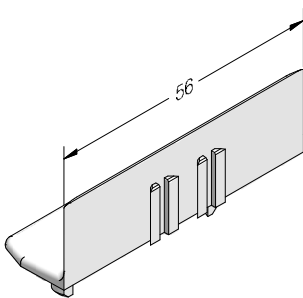

Endkappe Stulpprofil außen SYNEGO®

ASA

1358024

50

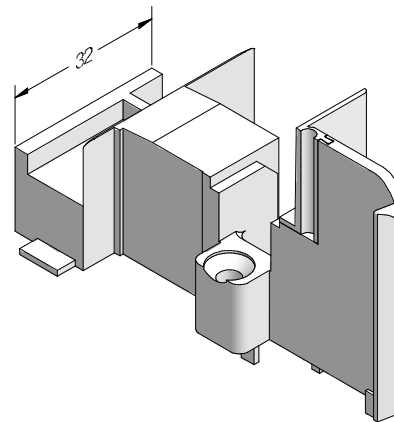

Endkappe Stulpprofil innen SYNEGO®

ASA/TPE

1358026

1358027

50

Profile für mehrflügelige Fenster ohne festen Pfosten

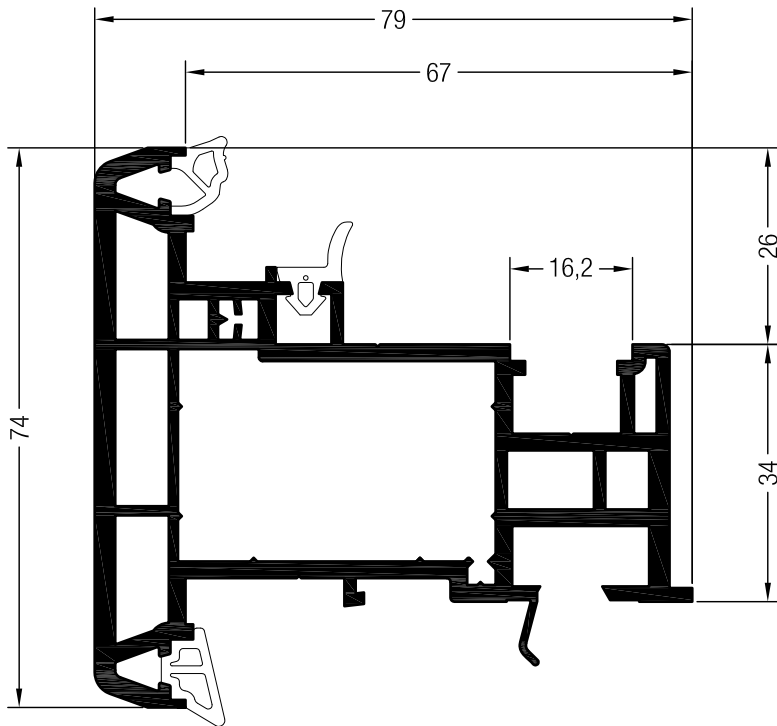

Blindpfosten SYNEGO®

- 1537455**
- 1567455**
- 24

Blindpfosten SYNEGO® für Alu-Vorsatzschale (ohne Universal- und Stulpdichtung)

- 1537450**
- 24

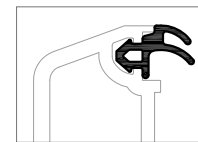

	1232881
	1232871

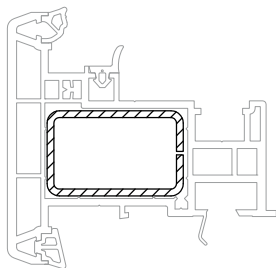

40 x 25

	1357552
	2
lx	4,8
ly	2,3
	6

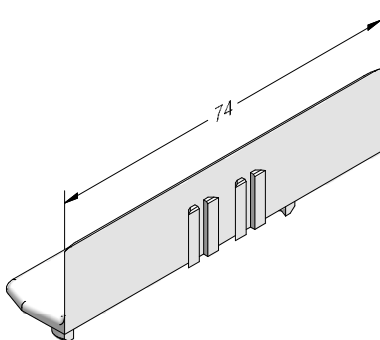

Endkappe Blindpfosten außen SYNEGO®

ASA

- 1358034**
- 50

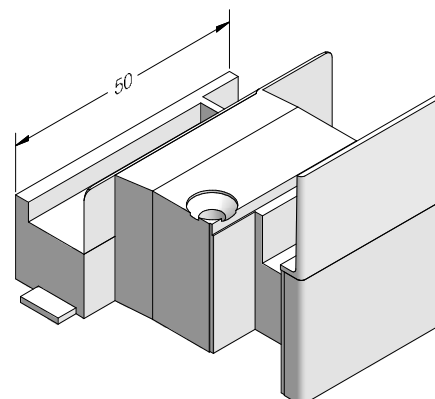

Endkappe Blindpfosten innen SYNEGO®

ASA/TPE

- 1358036**
- 1358037**
- 50

Profile für mehrflügelige Fenster ohne festen Pfosten

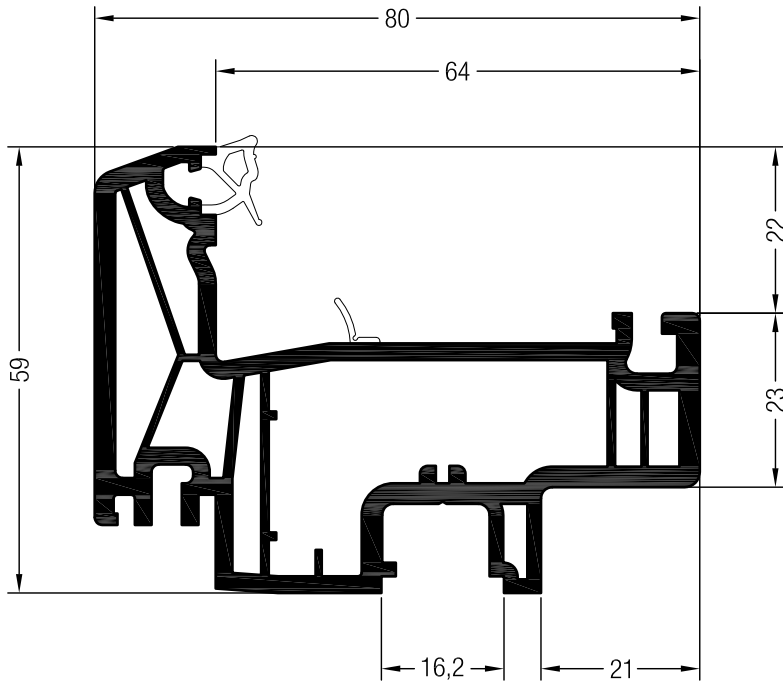

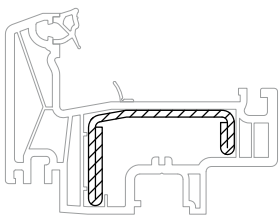

Stulpflügel Z 59 SYNEGO®

- 1537485  
- 1567485   @
-  24





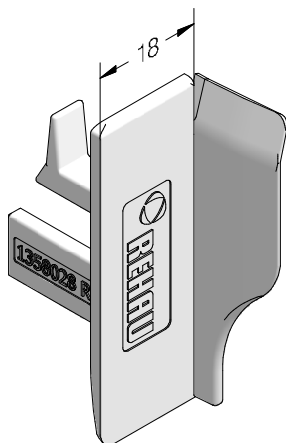

42,8 x 28

	1357554
	2
lx	5,6
ly	1,4
	6



Endkappe Stulpflügel SYNEGO®







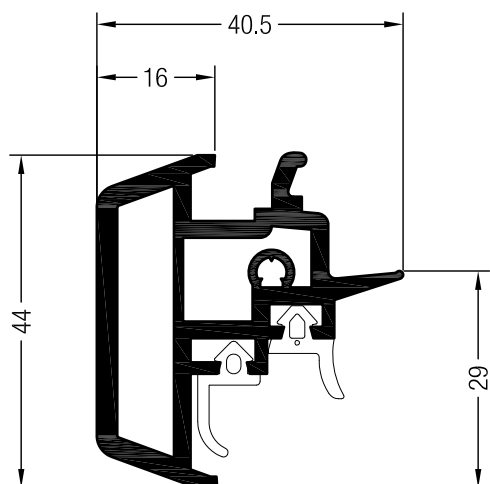



TPE

- 1358028  
- 1358029  
-  50

Profile für mehrflügelige Fenster ohne festen Pfosten



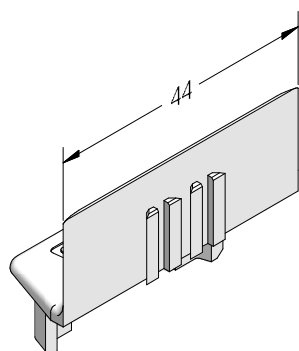

Stulpleiste SYNEGO®

- 1537495**   
  
- 1567495**   
 36



Endkappe Stulpleiste außen SYNEGO®

ASA



1358110   

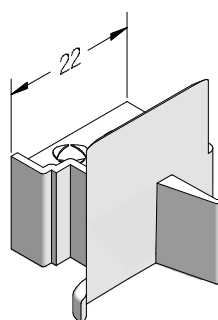

 50



Endkappe Stulpleiste innen SYNEGO®

ASA

1358038   

1358039   

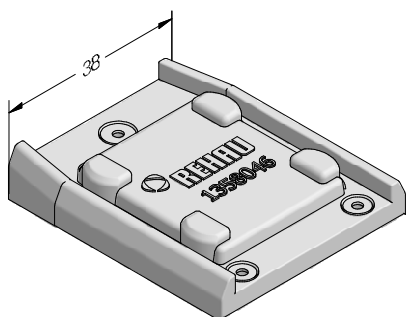

 50

Zubehör für mechanische Verbindungen



Mechanischer Verbinder Pfosten 96 AD SYNEGO®

TPE

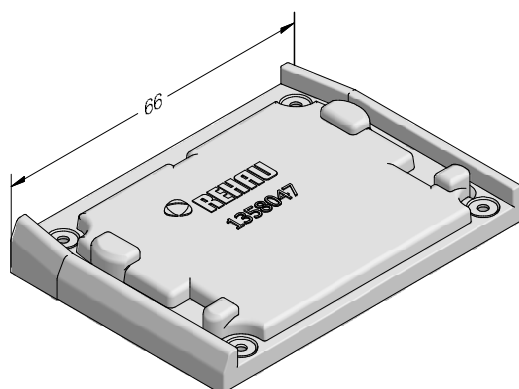

1358046   

 50



Mechanischer Verbinder Pfosten 124 AD SYNEGO®

TPE

1358047   

 50

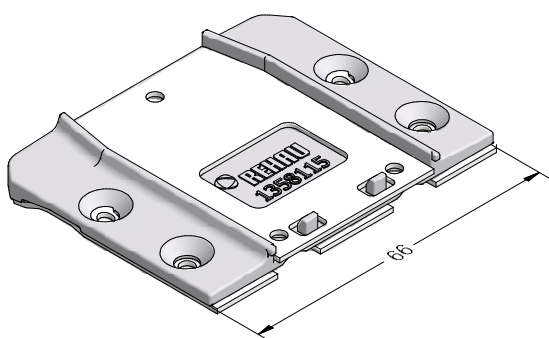

Mechanischer Verbinder Pfosten 96 AD SYNEGO®

Zink-Druckguss

1358115 

 50

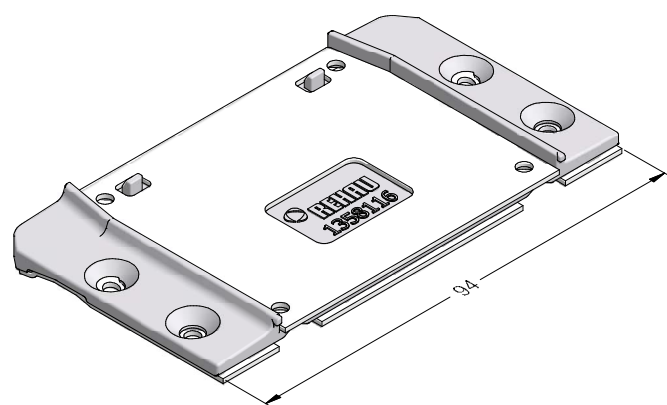

Mechanischer Verbinder Pfosten 124 AD SYNEGO®

Zink-Druckguss

1358116 

 50

Zubehör für mechanische Verbindungen

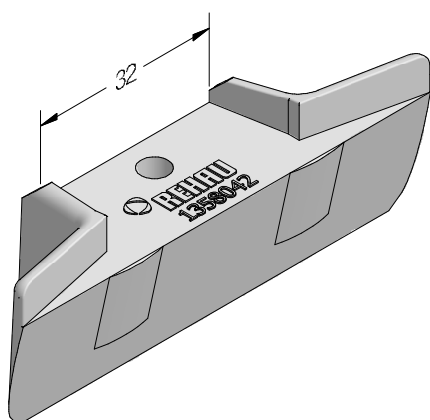

Dichtblock Pfosten 96 MD SYNEGO®

TPE

1358042 ■ ■

 50

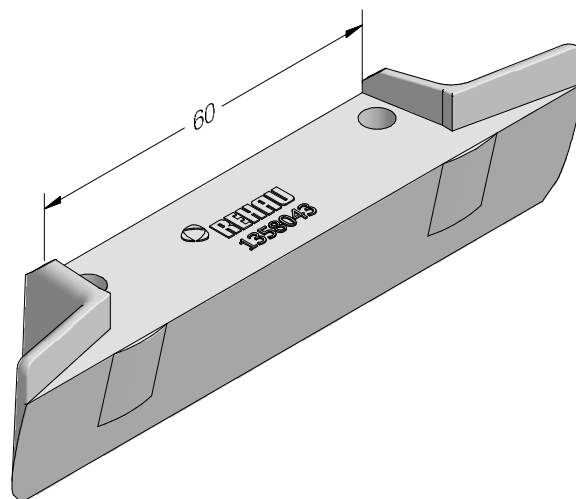

Dichtblock Pfosten 124 MD SYNEGO®

TPE

1358043 ■ ■

 50

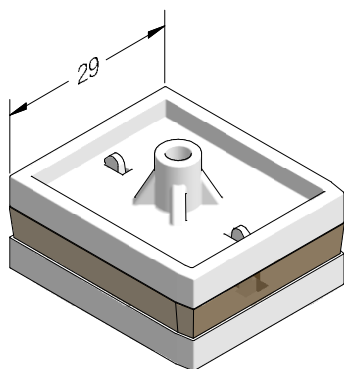

Dichtteil Pfosten 96 MD SYNEGO®

PA/TPE

1358058 

 50

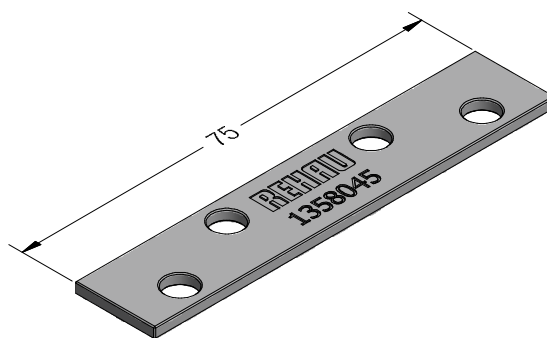

Montageplatte Pfosten 96 und 124 SYNEGO®



Stahl verzinkt

1358045 

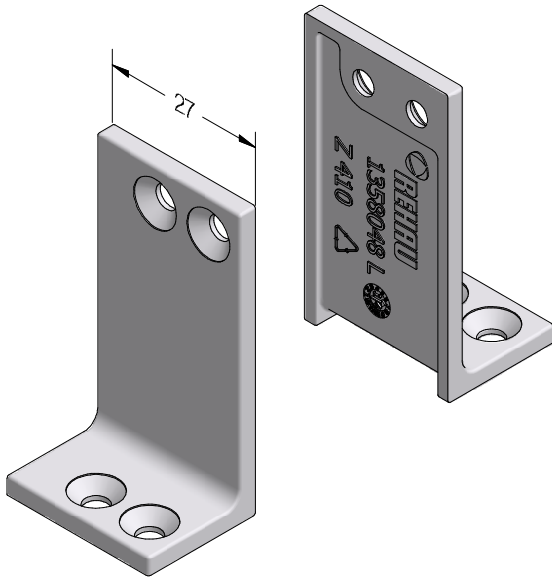

 400

Zubehör für mechanische Verbindungen

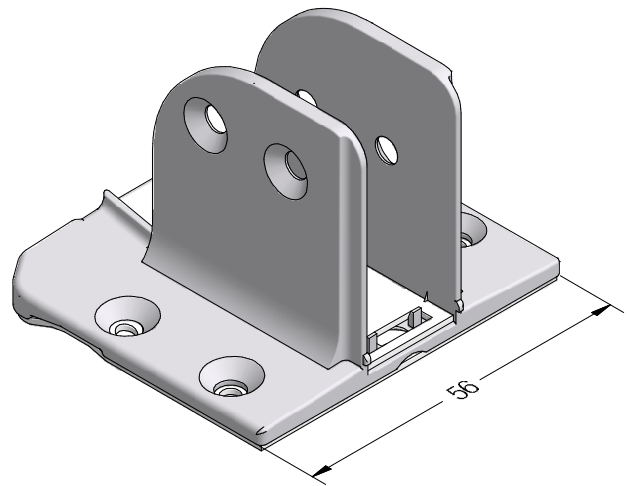

Set Pfostenwinkel Kreuzstoß Pfosten MD SYNEGO®
Zink-Druckguss
1358048 
 20



Mechanischer Verbinder Sprosse 68 SYNEGO®
Zink-Druckguss
1358044 
 50

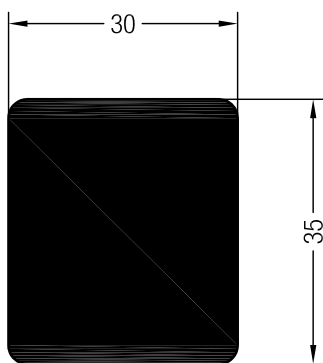

Mechanischer Verbinder universal Pfosten 96 SYNEGO®
30 x 35
1358033 
 2

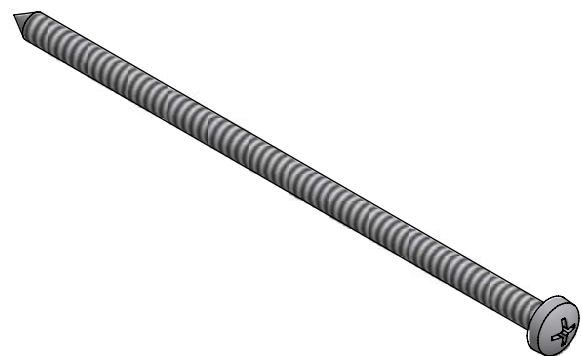

Blechschaube ISO 7049, 4,2 x 100
Stahl verzinkt
1247725
 200

Blechschaube ISO 7049, 4,2 x 120
Stahl verzinkt
1207679
 100

Bodenschwelle und Zubehör

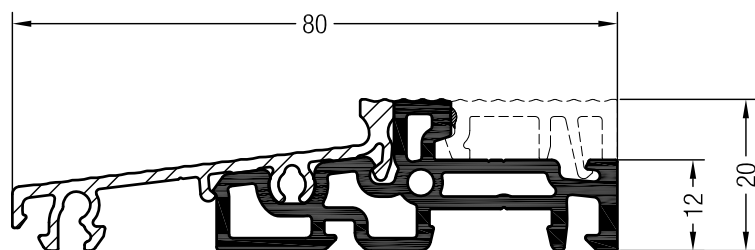
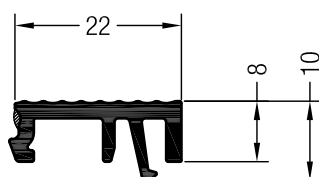

Set Bodenschwelle Bautiefe 80

1356663 

 6

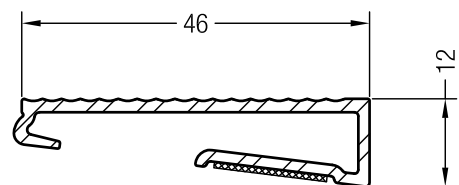

Deckelprofil auswärts öffnend Bautiefe 80

1356673 

 6

Bodenschwelle und Zubehör

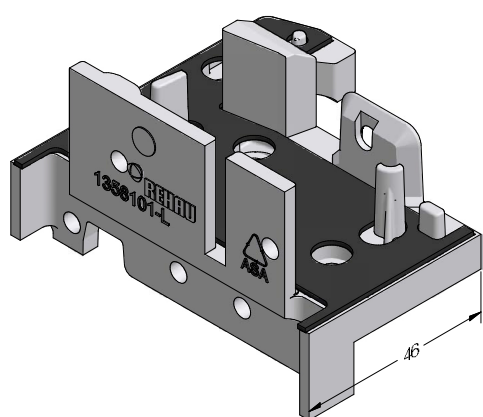

Schwellenhalter Blendrahmen 72 SYNEGO®

ASA

1358100

1358101

50

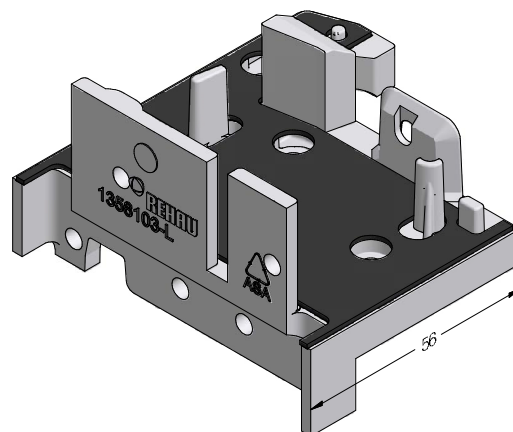

Schwellenhalter Blendrahmen 82 SYNEGO®

ASA

1358102

1358103

50

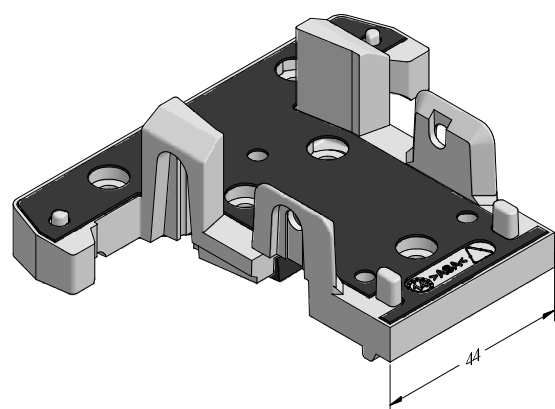

Schwellenhalter Pfosten 96 SYNEGO®

ASA

1358104

50

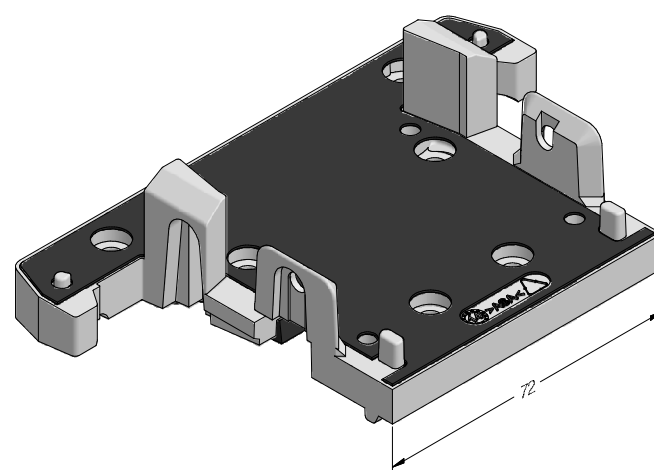

Schwellenhalter Pfosten 124 SYNEGO®

ASA

1358105

50

Bodenschwelle und Zubehör

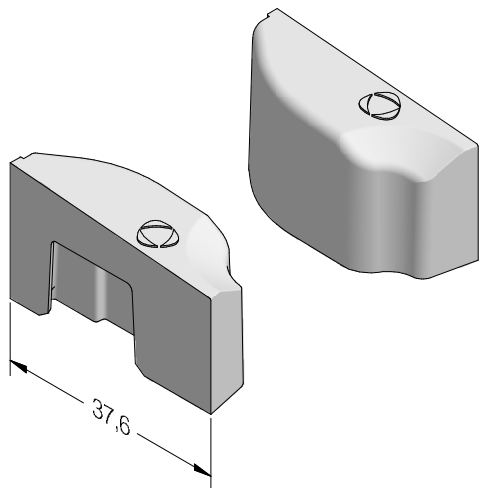

Set Windstopp AD SYNEGO®

TPE

1358108 ■

 50

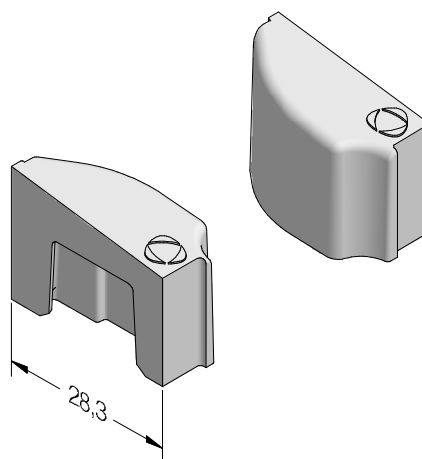

Set Windstopp MD SYNEGO®

TPE

1358109 ■

 50

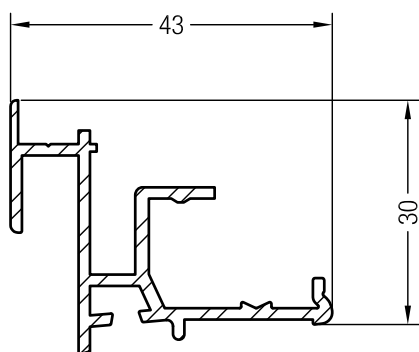



Ausgleichsprofil SYNEGO®

1357344 ▨

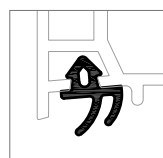
 6



	1865530
	1864952
	500

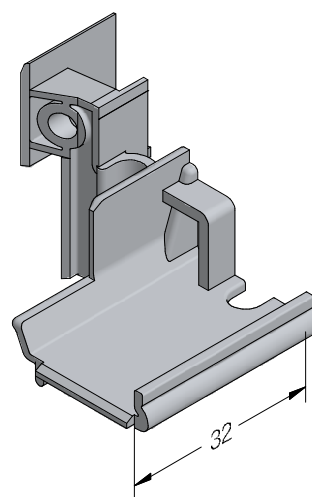

Endkappe Ausgleichsprofil SYNEGO®

ASA

1358056 ↶ ■

1358057 ↷ ■

 50

Bodenschwelle und Zubehör

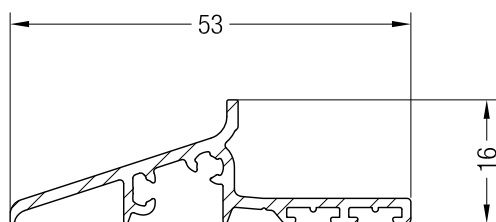



Wetterschenkel SYNEGO®

1357341 

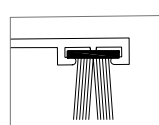
 6





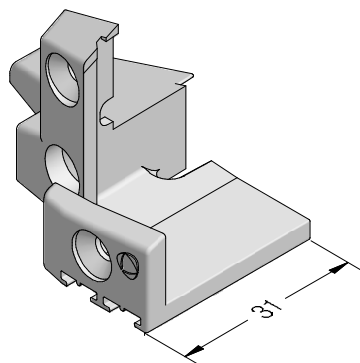

	1248095
	50



Endkappe Wetterschenkel SYNEGO®

ASA

1358052  

1358053  

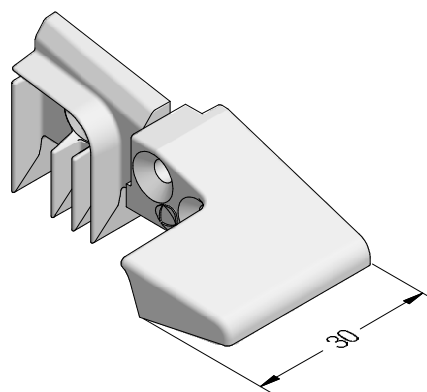

 50



Endkappe Wetterschenkel Stulp SYNEGO®

ASA

1358054  

1358055  

 50

Bodenschwelle und Zubehör

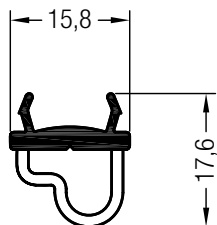

Kältestopp

1353383 

 6

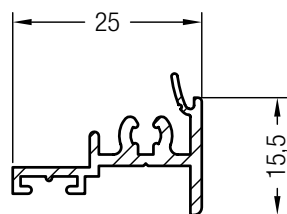



Deckleiste Flügel T SYNEGO®

1353550 

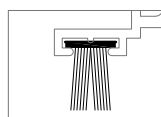
 6



	1248095
	50

Zubehör auswärts öffnende Elemente

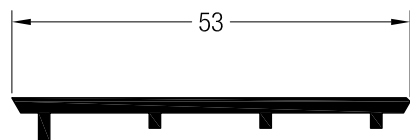

Falzeinlageprofil SYNEGO®

1537340   @  @

 72

Zubehör für Haus- und Nebeneingangstüren

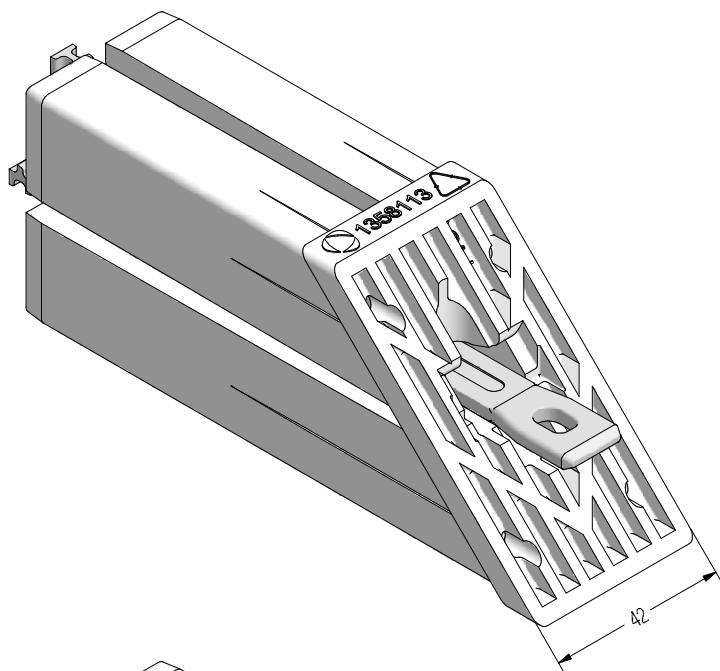

Schweißbarer Eckverbinder HT-Flügel SYNEGO®

PVC-U

1358113 

 96

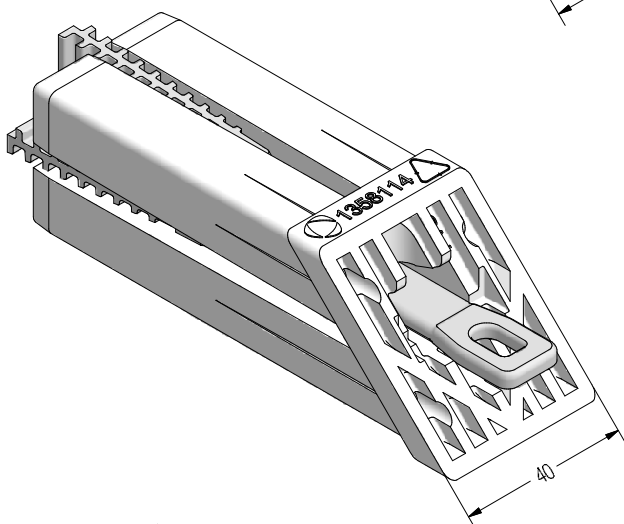

Schweißbarer Eckverbinder Flügel 86/106 SYNEGO®

PVC-U

1358114 

 96

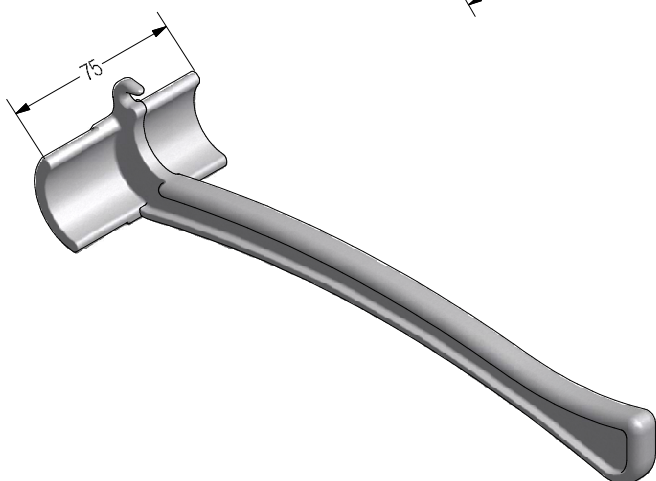

Spannhebel

Zink-Druckguss

1353616 

 1

Bohrlehren

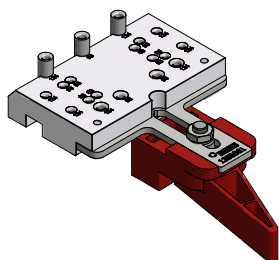

Bohrlehre mech. Verbinder Pfosten/Sprosse AD SYNEGO®
(Bohrlehre für Blendrahmen SYNEGO® AD,
Bohrlehre für Pfosten SYNEGO® AD in Verbindung mit Kreuzstoß,
Bohrlehre Flügel SYNEGO® in Verbindung mit Sprosse 68 SYNEGO®)

1358061



1

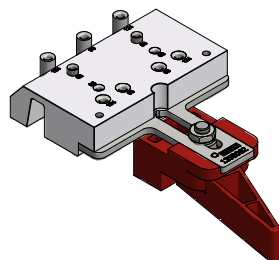

Bohrlehre mech. Verbinder Pfosten/Sprosse MD SYNEGO®
(Bohrlehre für Blendrahmen SYNEGO® MD,
Bohrlehre für Flügel SYNEGO® in Verbindung mit Sprosse 68 SYNEGO®)

1358062



1

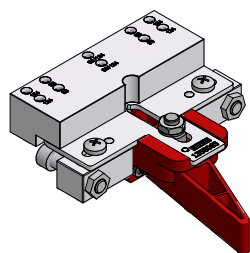

Bohrlehre mech. Verbinder Pfostenwinkel SYNEGO®
(Bohrlehre für Pfosten SYNEGO® MD in Verbindung mit Kreuzstoß)

1358063



1

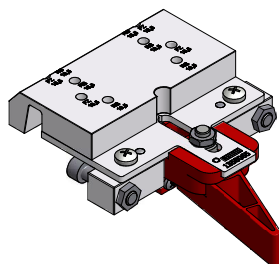

Bohrlehre Schwellenhalter SYNEGO®
(Bohrlehre für Blendrahmen und Pfosten SYNEGO® AD/MD)

1358065



1

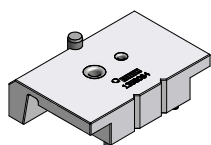

Bohrlehre Elementkopplung SYNEGO®

1358064



1

Armierungen

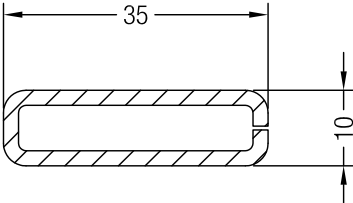
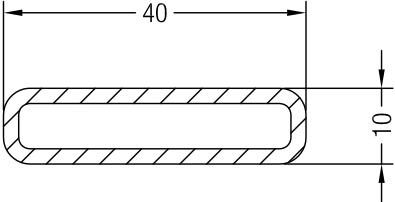
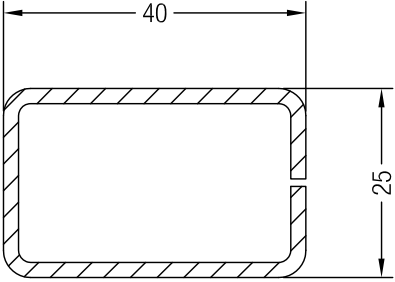
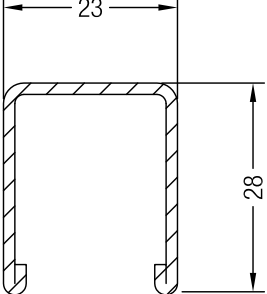
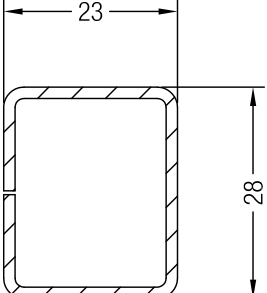
	Art.-Nr.		lx	ly
	1261801	2	1,8	0,22
	1247898	2	2,7	0,25
	1357552	2	4,8	2,3
	1306619	1,5	1,1	1,1
	1357540	1,5	1,1	1,5

Armierungen

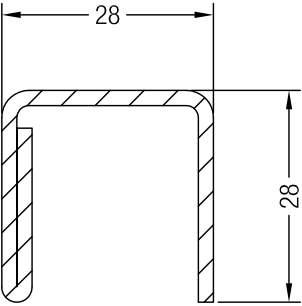
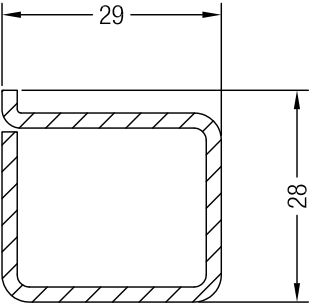
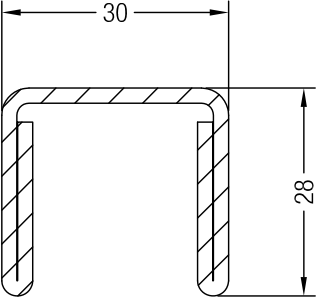
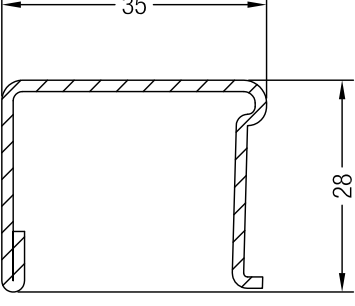
	Art.-Nr.		lx	ly
	1313130	2	2,5	1,6
	1357550	2	2,3	1,8
	1306617	2	3,7	1,9
	1244516	1,5	2,7	1,3
	1244526	2	3,5	1,7

Armierungen

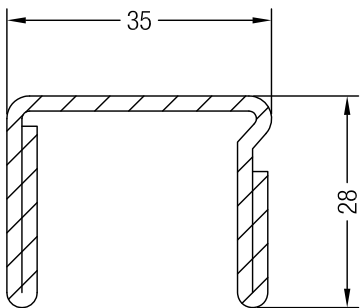
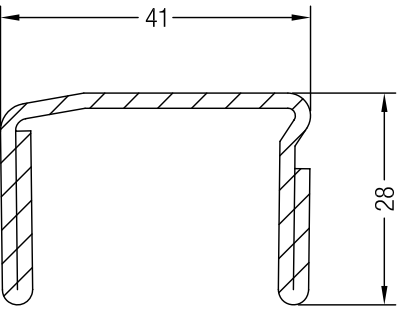
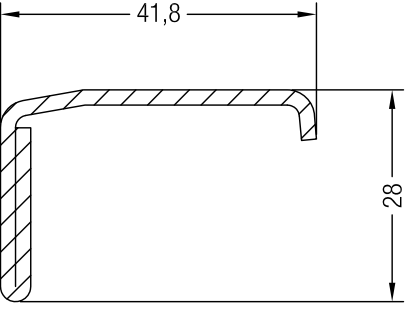
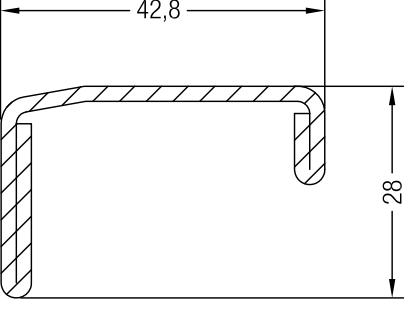
	Art.-Nr.		lx	ly
	1244536	2	5	2
	1352512	2	7,1	2,1
	1352515	2	3,3	1,4
	1357554	2	5,6	1,4

Armierungen

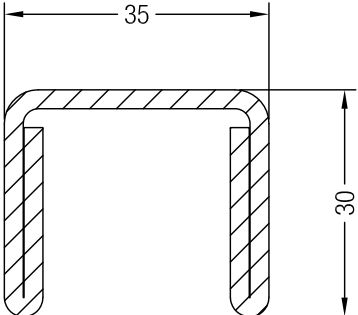
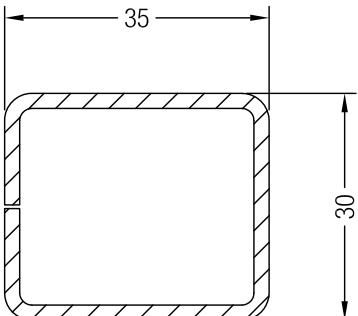
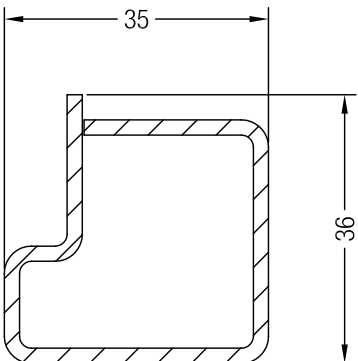
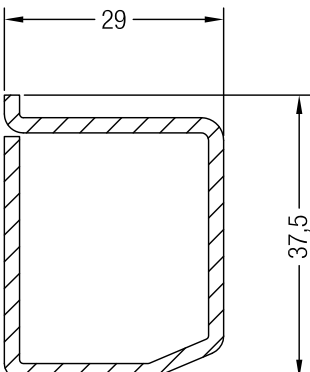
	Art.-Nr.		lx	ly
	1357551	2,5	6,6	2,9
	1357544	2	4	3,1
	1357543	2	3,6	3,7
	1357559	2	2,9	3,9

Armierungen

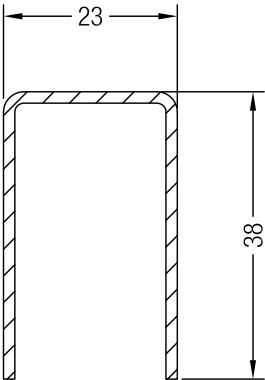
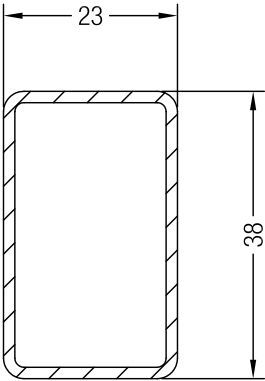
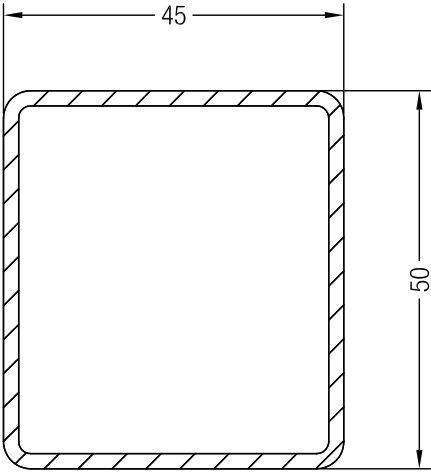
	Art.-Nr.		lx	ly
	1357541	1,5	1,4	2,1
	1357542	1,5	1,5	3,2
	1357545	2	11,1	13,1

Armierungen

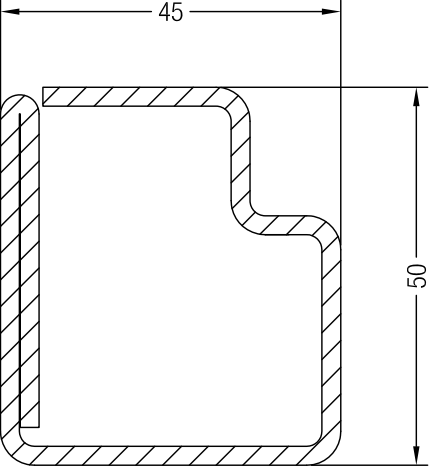
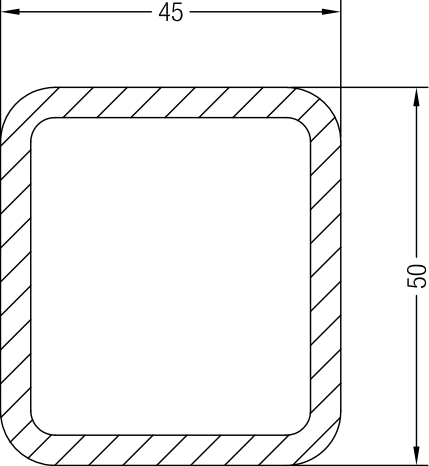
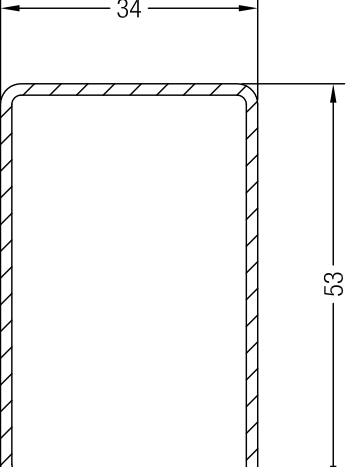
	Art.-Nr.		lx	ly
	1357546	2,5	14,1	15,4
	1357553@	4	18,6	22
	1357547	1,5	4,6	6,5

Armierungen

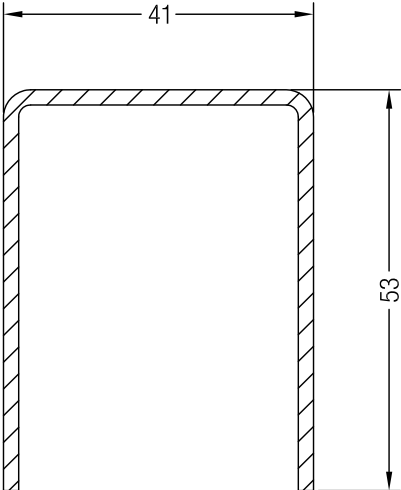
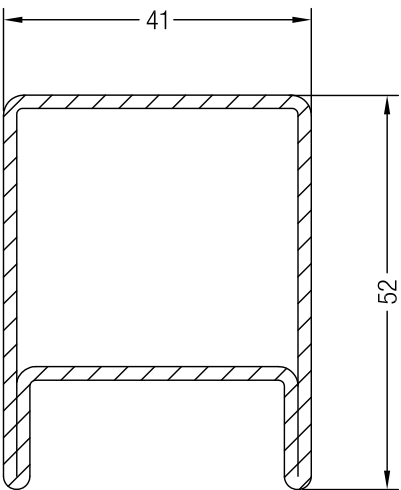
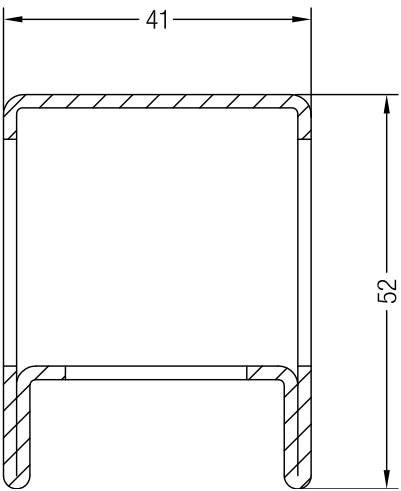
	Art.-Nr.		lx	ly
	1357548	2	8,7	8,4
	1357597	1,75	9,7	10,5
	1357598	1,75	vorkonfektioniert für Schlosseite	

Armierungen

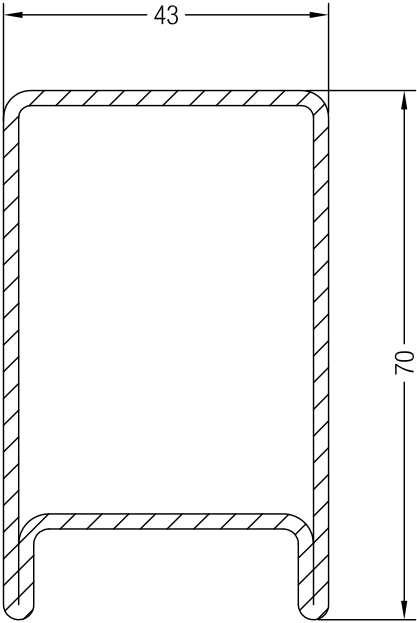
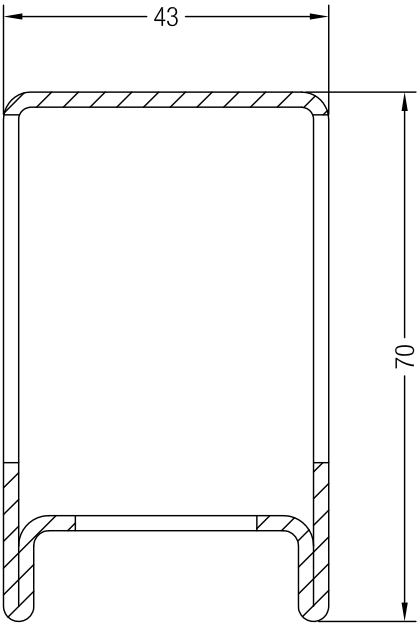
	Art.-Nr.		lx	ly
	1357549	2	14,9	27,1
	1357556	2	vorkonfektioniert für Schlosseite	

Artikelverzeichnis

Art.-Nr.	Bezeichnung	Pack/ Bündel in m	Langgutpalette in m		Karton/ Beutel in Stück	Seite
			Pack	Schrumpf		
1207679	Schraube 4,2 x 120				100	24
1232871	Ahlagdichtung Blendrahmen schwarz	300				2
1232881	Ahlagdichtung Blendrahmen grau	300				2
1244516	Armierung 35 x 28 x 1,5	6/432				33
1244526	Armierung 35 x 28 x 2	6/432				33
1244536	Armierung 35 x 28 x 2	6/312				34
1247725	Schraube 4,2 x 100				200	24
1247898	Armierung 40 x 10 x 2	6/378				32
1248095	Bürstendichtung 6,7 x 9				50	29
1261801	Armierung 35 x 10 x 2	6/480				32
1306617	Armierung 30 x 28 x 2	6/300				33
1306619	Armierung 23 x 28 x 1,5	6/504				32
1313130	Armierung 28 x 28 x 2	6/396				33
1352512	Armierung 41 x 28 x 2	6/288				34
1352515	Armierung 41,8 x 28 x 2	6/384				34
1353383	Kältestopp	6				29
1353550	Deckleiste Flügel T SYNEGO®	6				29
1353616	Spannhebel	1				30
1356663	Set Bodenschwelle Bautiefe 80	6				25
1356673	Deckelprofil auswärts öffnend Bautiefe 80	6				25
1357341	Wetterschenkel SYNEGO®	6				28
1357344	Ausgleichsprofil SYNEGO®	6				27
1357540	Armierung 23 x 28 x 1,5	6/300				32
1357541	Armierung 23 x 38 x 1,5	6/300				36
1357542	Armierung 23 x 38 x 1,5	6/300				36
1357543	G-Armierung 35 x 36 x 2	6/300				35
1357544	Armierung 35 x 30 x 2	6/420				35
1357545	Armierung 45 x 50 x 2	6/192				36
1357546	G-Armierung 45 x 50 x 2,5	6/300				37
1357547	Armierung 34 x 53 x 1,5	6/420				37
1357548	Armierung 41 x 53 x 2	6/420				38
1357549	Armierung 43 x 70 x 2	6/150				39
1357550	Armierung 29 x 28 x 2	6				33
1357551	Armierung 35 x 30 x 2,5	6				35
1357552	Armierung 40 x 25 x 2	6/300				32
1357553@	Armierung 45 x 50 x 4	6				37
1357554	Armierung 42,8 x 28 x 2	6				34
1357556	Armierung 43 x 70 x 2, konfektioniert	2,4				39
1357559	Armierung 29 x 37,5 x 2	6				35
1357597	Armierung 41 x 52 x 1,75	6				38
1357598	Armierung 41 x 52 x 1,75, konfektioniert	2,2				38

Artikelverzeichnis

Art.-Nr.	Bezeichnung	Pack/ Bündel in m	Langgutpalette in m		Karton/ Beutel in Stück	Seite
			Pack	Schrumpf		
1358024	Endkappe Stulpprofil außen SYNEGO®				50	18
1358026	Endkappe Stulpprofil innen SYNEGO® (rechts)				50	18
1358027	Endkappe Stulpprofil innen SYNEGO® (links)				50	18
1358028	Endkappe Stulpflügel SYNEGO® (rechts)				50	20
1358029	Endkappe Stulpflügel SYNEGO® (links)				50	20
1358033	Mechanischer Verbinder universal Pfosten 96 SYNEGO®	2				24
1358034	Endkappe Blindpfosten außen SYNEGO®				50	19
1358036	Endkappe Blindpfosten innen SYNEGO® (rechts)				50	19
1358037	Endkappe Blindpfosten innen SYNEGO® (links)				50	19
1358038	Endkappe Stulpleiste innen SYNEGO® (rechts)				50	21
1358039	Endkappe Stulpleiste innen SYNEGO® (links)				50	21
1358042	Dichtblock Pfosten 96 MD SYNEGO®				50	23
1358043	Dichtblock Pfosten 124 MD SYNEGO®				50	23
1358044	Mechanischer Verbinder Sprosse 68 SYNEGO®				50	24
1358045	Montageplatte Pfosten 96 nd 124 SYNEGO®				400	23
1358046	Mechanischer Verbinder Pfosten 96 AD SYNEGO®				50	22
1358047	Mechanischer Verbinder Pfosten 124 AD SYNEGO®				50	22
1358048	Set Pfostenwinkel SYNEGO®				20	24
1358052	Endkappe Wetterschenkel SYNEGO® (rechts)				50	28
1358053	Endkappe Wetterschenkel SYNEGO® (links)				50	28
1358054	Endkappe Wetterschenkel Stulp SYNEGO® (rechts)				50	28
1358055	Endkappe Wetterschenkel Stulp SYNEGO® (links)				50	28
1358056	Endkappe Ausgleichsprofil SYNEGO® (rechts)				50	27
1358057	Endkappe Ausgleichsprofil SYNEGO® (links)				50	27
1358058	Dichtteil Pfosten 96 MD SYNEGO®				50	23
1358061	Bohrlehre mech. Verbinder Pfosten/Sprosse AD SYNEGO®				1	31
1358062	Bohrlehre mech. Verbinder Pfosten/Sprosse MD SYNEGO®				1	31
1358063	Bohrlehre mech. Verbinder Pfostenwinkel SYNEGO®				1	31
1358064	Bohrlehre Elementkopplung SYNEGO®				1	31
1358065	Bohrlehre Schwellenhalter SYNEGO®				1	31
1358100	Schwellenhalter Blendrahmen 72 SYNEGO® (rechts)				50	26
1358101	Schwellenhalter Blendrahmen 72 SYNEGO® (links)				50	26
1358102	Schwellenhalter Blendrahmen 82 SYNEGO® (rechts)				50	26
1358103	Schwellenhalter Blendrahmen 82 SYNEGO® (links)				50	26
1358104	Schwellenhalter Pfosten 96 SYNEGO®				50	26
1358105	Schwellenhalter Pfosten 124 SYNEGO®				50	26
1358108	Set Windstopp AD SYNEGO®				50	27
1358109	Set Windstopp MD SYNEGO®				50	27
1358110	Endkappe Stulpleiste außen SYNEGO®				50	21
1358113	Schweißbarer Eckverbinder HT-Flügel SYNEGO®				96	30
1358114	Schweißbarer Eckverbinder Flügel 86/106 SYNEGO®				96	30

Artikelverzeichnis

Art.-Nr.	Bezeichnung	Pack/ Bündel in m	Langgutpalette in m		Karton/ Beutel in Stück	Seite
			Pack	Schrumpf		
1358115	Mechanischer Verbinder Pfosten 96 SYNEGO®				50	22
1537000	Blendrahmen 72 AD SYNEGO® (ohne Universaldichtung)	24	360	396		2
1537005	Blendrahmen 72 AD SYNEGO®	24	360	396		2
1537010	Blendrahmen 82 AD SYNEGO® (ohne Universaldichtung)	24	288	378		3
1537015	Blendrahmen 82 AD SYNEGO®	24	288	378		3
1537100	Blendrahmen 72 MD SYNEGO® (ohne Universaldichtung)	24	360	462		6
1537105	Blendrahmen 72 MD SYNEGO®	24	360	462		6
1537110	Blendrahmen 82 MD SYNEGO® (ohne Universaldichtung)	24	288	378		7
1537115	Blendrahmen 82 MD SYNEGO®	24	288	378		7
1537165	Blendrahmen 72/40 MD SYNEGO®	24	360			8
1537215	Flügel Z 59 SYNEGO®	24	360	462		11
1537235	Flügel Z 86 SYNEGO®	24	216	294		13
1537245	Flügel 59 rund SYNEGO®	24	360	396		12
1537295	Haustürflügel Z SYNEGO®	13	234	234		15
1537305	Haustürflügel T SYNEGO®	13	234	234		16
1537315	Flügel T 106 SYNEGO®	12	216	252		14
1537340	Falzeinlageprofil SYNEGO®	72				29
1537400	Pfosten 96 AD SYNEGO® (ohne Universaldichtungen)	24	288	324		4
1537405	Pfosten 96 AD SYNEGO®	24	288	324		4
1537410	Pfosten 124 AD SYNEGO® (ohne Universaldichtungen)	12	252	252		5
1537415	Pfosten 124 AD SYNEGO®	12	252	252		5
1537425	Sprosse 68 SYNEGO®	36	432	588		17
1537440	Stulpprofil SYNEGO® (ohne Universal- und Stulpdichtung)	24	600			18
1537445	Stulpprofil SYNEGO®	24	600			18
1537450	Blindpfosten SYNEGO® (ohne Universal- und Stulpdichtung)	24	360			19
1537455	Blindpfosten SYNEGO®	24	360			19
1537485	Stulpflügel 59 SYNEGO®	24	504			20
1537495	Stupleiste SYNEGO®	36	1620			21
1537500	Pfosten 96 MD SYNEGO® (ohne Universaldichtungen)	24	288	324		9
1537505	Pfosten 96 MD SYNEGO®	24	288	324		9
1537510	Pfosten 124 MD SYNEGO® (ohne Universaldichtungen)	12	252	252		10
1537515	Pfosten 124 MD SYNEGO®	12	252	252		10
1567005	Blendrahmen 72 AD SYNEGO® (kaschiert)	24	360			2
1567015	Blendrahmen 82 AD SYNEGO® (kaschiert)	24	288			3
1567105	Blendrahmen 72 MD SYNEGO® (kaschiert)	24	360			6
1567115	Blendrahmen 82 MD SYNEGO® (kaschiert)	24	288			7
1567165	Blendrahmen 72/40 MD SYNEGO® (kaschiert)	24	360			8
1567215	Flügel Z 59 SYNEGO® (kaschiert)	24	360			11
1567235	Flügel Z 86 SYNEGO® (kaschiert)	24	216			13
1567245	Flügel 59 rund SYNEGO® (kaschiert)	24	360			12
1567295	Haustürflügel Z SYNEGO® (kaschiert)	13	234			15































Artikelverzeichnis

Art.-Nr.	Bezeichnung	Pack/ Bündel in m	Langgutpalette in m		Karton/ Beutel in Stück	Seite
			Pack	Schrumpf		
1567305	Haustürflügel T SYNEGO® (kaschiert)	13	234			16
1567315	Flügel T 106 SYNEGO® (kaschiert)	12	216			14
1567405	Pfosten 96 AD SYNEGO® (kaschiert)	24	288			4
1567415	Pfosten 124 AD SYNEGO® (kaschiert)	12	252			5
1567425	Sprosse 68 SYNEGO® (kaschiert)	36	432			17
1567445	Stulpprofil SYNEGO® (kaschiert)	24	600			18
1567455	Blindpfosten SYNEGO® (kaschiert)	24	360			19
1567485	Stulpflügel 59 SYNEGO® (kaschiert)	24	504			20
1567495	Stulpleiste SYNEGO® (kaschiert)	36	1620			21
1567505	Pfosten 96 MD SYNEGO® (kaschiert)	24	288			9
1567515	Pfosten 124 MD SYNEGO® (kaschiert)	12	252			10
1865530	Anschlagdichtung grau	500				27
1864952	Anschlagdichtung schwarz	500				27

MASTERVORLAGE

ist den landesspezifischen Vorgaben
anzupassen. Stand 01.2015

Zeichenerklärung

	Farbe Schwarz
	Farbe Grau
	Farbe Weiß
	Farbe Cremeweiß
	Farbe Braun
	Farbe Karamell
	Farbe Grün
	Farbe Rot
	Farbe Silber
	Farbe beliebig
	Aluminium natur eloxiert
	Aluminium pressblank
	Kaschierte Ausführung
	Lackierte Ausführung
	Verpackungseinheit (Details siehe Artikelverzeichnis)
	Wanddicke in mm
	Mit verschweißbarer Dichtung
	Mit nicht verschweißbarer Dichtung
	Manuell einzuziehende Dichtung
	Rechte Ausführung
	Linke Ausführung
@	Außerstandard, Lieferzeit auf Anfrage
I_x	Trägheitsmoment in X-Richtung in cm^4 bezogen auf E-Modul von Stahl
I_y	Trägheitsmoment in Y-Richtung in cm^4 bezogen auf E-Modul von Stahl
	Mit PVC-Kleber verkleben, weiße Profile mit Kleber 1251660/1251670, kaschierte Profile mit lösemittelfreien Klebstoff (z.B. Cosmofen 515, Fa. Weiss).
	Mit Silikon abdichten
	Mit EPDM-Dichtmasse abdichten
	Mit EPDM-Kleber verkleben
	Linienkopf-Blechschaube ISO 7049
	Senkkopf-Blechschaube ISO 7050
	Senkkopf-Bohrschraube ISO 15482
	Linienkopf-Bohrschraube ISO 15481
	Bohr- und Schneidlehre
	Fräsbild
	Alu-Vorsatzschale

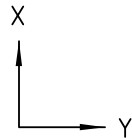

Variantsystematik

Weiße Profile:

Nach der Artikelnummer (z.B. 1537005) folgt eine 4-stellige Variante (z.B. 1701), die bei Haupt- und Zusatzprofilen gleichermaßen aufgebaut ist.



Die Variante besteht aus jeweils 4 Stellen:



- 1. und 2. Stelle: Verpackungsart
- 3. und 4. Stelle: Farbnummer

1. und 2. Stelle	Verpackungsart
17	Schlauch-Langgutpalette (LGP)
19	Schrumpf-Langgutpalette (LGP)

3. und 4. Stelle	Farbnummer	
	Profil	Profil/Dichtung
01	Weiß 159	Weiß/Schwarz 159/601
05	Weiß 159	Weiß/Weiß 159/159
15	-	Weiß/Grau 159/RAL 7001

Beispiele:

XXXXXXX  - Artikel in Weiß ohne Dichtung
 36
 kleinste Verpackungseinheit 36 m
 Variante 1701: Schlauch-LGP
 Variante 1901: Schrumpf-LGP

XXXXXXX   - Artikel in Weiß mit weißer Dichtung
 24
 kleinste Verpackungseinheit 24 m
 Variante 1705: Schlauch-LGP
 Variante 1905: Schrumpf-LGP



XXXXXXX   - Artikel in Weiß mit grauer Dichtung
 36
 kleinste Verpackungseinheit 36 m
 Variante 1715: Schlauch-LGP
 Variante 1915: Schrumpf-LGP

 Achtung: Nicht alle Profile werden in allen oben gelisteten Varianten angeboten.

Kaschierte Profile:

Für kaschierte Profile ist abhängig von der gewünschten Farbkombination eine 4-stellige Farbvariante aus dem Standardfarbtableau zu entnehmen. Kaschierte Profile werden generell in der Verpackungsart Schlauch-Langgutpalette geliefert.

Beispiele:

XXXXXXX   - Artikel kaschiert mit schwarzer Dichtung
 24
 kleinste Verpackungseinheit 24 m
 Verpackung generell in Schlauch-LGP
 Farbvariante nach Standardfarbtableau

Materialnummer

Die 7-stellige Artikelnummer (z.B. 1537005) wird mit der 4-stelligen Variante (z.B. 1701) zu einer 11-stelligen Materialnummer zusammengefasst (z.B. 15370051701).

Tableau Standardfarben









Golden oak 7512	Karamel 15874	Golden oak 7512	1284	1284	1284	1284	1284	1284	1284	1284	1284	1284
Mooreiche 2 4914	Braun 16827	Mooreiche 2 4914	1756	1756	1756	1756	1756	1756	1756	1756	1756	1756
Eiche dunkel 1 9638	Braun 16827	Eiche dunkel 1 9638	1752	1752	1752	1752	1752	1752	1752	1752	1752	1752
Mahagoni 9632	Braun 16827	Mahagoni 9632	1751	1751	1751	1751	1751	1751	1751	1751	1751	1751
Braun genarbt 9631	Braun 16827	Braun genarbt 9631	1750	1750	1750	1750	1750	1750	1750	1750	1750	1750
Nussbaum 225L	Braun 16827	Nussbaum 225L	1165	1165	1165	1165	1165	1165	1165	1165	1165	1165
Anthrazitgrau genarbt 4443	Braun 16827	Anthrazitgrau genarbt 4443	1464	1464	1464	1464	1464	1464	1464	1464	1464	1464
Anthrazitgrau glatt 930L	Braun 16827	Anthrazitgrau glatt 930L	1493	1493	1493	1493	1493	1493	1493	1493	1493	1493
Anthrazitgrau genarbt 4443	Weiß 159	Anthrazitgrau genarbt 4443	1364	1364	1364	1364	1364	1364	1364	1364	1364	1364
Anthrazitgrau glatt 930L	Weiß 159	Anthrazitgrau glatt 930L	1393	1393	1393	1393	1393	1393	1393	1393	1393	1393
Anthrazitgrau glatt 930L	Weiß 159		1093	1093	1093	1093	1093	1093	1093	1093	1093	1093
Anthrazitgrau genarbt 4443	Weiß 159		1746	1746	1746	1746	1746	1746	1746	1746	1746	1746
Mooreiche 2 4914	Weiß 159		1742	1742	1742	1742	1742	1742	1742	1742	1742	1742
Golden oak 7512	Weiß 159		1741	1741	1741	1741	1741	1741	1741	1741	1741	1741
Grau 9922	Weiß 159		1737	1737	1737	1737	1737	1737	1737	1737	1737	1737
Dunkelgrün 9773	Weiß 159		1732	1732	1732	1732	1732	1732	1732	1732	1732	1732
Eiche dunkel 1 9638	Weiß 159		1722	1722	1722	1722	1722	1722	1722	1722	1722	1722
Mahagoni 9632	Weiß 159		1721	1721	1721	1721	1721	1721	1721	1721	1721	1721
Braun genarbt 9631	Weiß 159		1720	1720	1720	1720	1720	1720	1720	1720	1720	1720
Nussbaum 225L	Weiß 159		1225	1225	1225	1225	1225	1225	1225	1225	1225	1225
Folienfarbe außen	Farbe Grundkörper (kann abweichen, wenn nicht im Sichtbereich)	Folienfarbe innen	Varianten									
			Bezeichnung									
			Art.-Nr	1567005	1567015	1567405	1567415	1567105	1567115	1567505	1567515	1567215
												

Tableau Standardfarben











			Varianten									
			1284	1284	1284	1284	1284	1284	1284	1284	1284	1284
Golden oak 7512	Karamel 15874	Golden oak 7512	1284	1284	1284	1284	1284	1284	1284	1284	1284	1284
Mooreiche 2 4914	Braun 16827	Mooreiche 2 4914	1756	1756	1756	1756	1756	1756	1756	1756	1756	1756
Eiche dunkel 1 9638	Braun 16827	Eiche dunkel 1 9638	1752	1752	1752	1752	1752	1752	1752	1752	1752	1752
Mahagoni 9632	Braun 16827	Mahagoni 9632	1751	1751	1751	1751	1751	1751	1751	1751	1751	1751
Braun genarbt 9631	Braun 16827	Braun genarbt 9631	1750	1750	1750	1750	1750	1750	1750	1750	1750	1750
Nussbaum 225L	Braun 16827	Nussbaum 225L	1165	1165	1165	1165	1165	1165	1165	1165	1165	1165
Anthrazitgrau genarbt 4443	Braun 16827	Anthrazitgrau genarbt 4443	1464	1464	1464	1464	1464	1464	1464	1464	1464	1464
Anthrazitgrau glatt 930L	Braun 16827	Anthrazitgrau glatt 930L	1493	1493	1493	1493	1493	1493	1493	1493	1493	1493
Anthrazitgrau genarbt 4443	Weiß 159	Anthrazitgrau genarbt 4443	1364	1364	1364	1364	1364	1364	1364	1364	1364	1364
Anthrazitgrau glatt 930L	Weiß 159	Anthrazitgrau glatt 930L	1393	1393	1393	1393	1393	1393	1393	1393	1393	1393
Anthrazitgrau glatt 930L	Weiß 159		1093	1093	1093	1093	1093	1093	1093	1093	1093	1093
Anthrazitgrau genarbt 4443	Weiß 159		1746	1746	1746	1746	1746	1746	1746	1746	1746	1746
Mooreiche 2 4914	Weiß 159		1742	1742	1742	1742	1742	1742	1742	1742	1742	1742
Golden oak 7512	Weiß 159		1741	1741	1741	1741	1741	1741	1741	1741	1741	1741
Grau 9922	Weiß 159		1737	1737	1737	1737	1737	1737	1737	1737	1737	1737
Dunkelgrün 9773	Weiß 159		1732	1732	1732	1732	1732	1732	1732	1732	1732	1732
Eiche dunkel 1 9638	Weiß 159		1722	1722	1722	1722	1722	1722	1722	1722	1722	1722
Mahagoni 9632	Weiß 159		1721	1721	1721	1721	1721	1721	1721	1721	1721	1721
Braun genarbt 9631	Weiß 159		1720	1720	1720	1720	1720	1720	1720	1720	1720	1720
Nussbaum 225L	Weiß 159		1225	1225	1225	1225	1225	1225	1225	1225	1225	1225
Folienfarbe außen	Farbe Grundkörper (kann abweichen, wenn nicht im Sichtbereich)	Folienfarbe innen	Varianten									
			Bezeichnung	Flügel 59 rund SYNEGO®	Flügel Z 86 SYNEGO®	Flügel T 106 SYNEGO®	Haustürrügel Z SYNEGO®	Hausrügel T SYNEGO®	Sprosse 68 SYNEGO®	Stuipprofil SYNEGO®	Blindposten SYNEGO®	Stuiprügel Z 59 SYNEGO®
			Art.-Nr	1567245	1567235	1567315	1567295	1567305	1567425	1567445	1567455	1567485
												

Tableau Standardfarben

Golden oak 7512	Karamel 15874	Golden oak 7512													
Mooreiche 2 4914	Braun 16827	Mooreiche 2 4914													
Eiche dunkel 1 9638	Braun 16827	Eiche dunkel 1 9638													
Mahagoni 9632	Braun 16827	Mahagoni 9632													
Braun genarbt 9631	Braun 16827	Braun genarbt 9631													
Nussbaum 225L	Braun 16827	Nussbaum 225L													
Anthrazitgrau genarbt 4443	Braun 16827	Anthrazitgrau genarbt 4443													
Anthrazitgrau glatt 930L	Braun 16827	Anthrazitgrau glatt 930L													
Anthrazitgrau genarbt 4443	Weiß 159	Anthrazitgrau genarbt 4443	Varianten												
Anthrazitgrau glatt 930L	Weiß 159	Anthrazitgrau glatt 930L													
Anthrazitgrau glatt 930L	Weiß 159														
Anthrazitgrau genarbt 4443	Weiß 159														
Mooreiche 2 4914	Weiß 159														
Golden oak 7512	Weiß 159														
Grau 9922	Weiß 159														
Dunkelgrün 9773	Weiß 159														
Eiche dunkel 1 9638	Weiß 159														
Mahagoni 9632	Weiß 159														
Braun genarbt 9631	Weiß 159														
Nussbaum 225L	Weiß 159														
Folienfarbe außen	Farbe Grundkörper (kann abweichen, wenn nicht im Sichtbereich)	Folienfarbe innen													
				Bezeichnung	Stujpleiste SYNEGO®										
				Art.-Nr	1567495										
															

Die in dieser Drucksache angegebenen Maße sind ungefähre Angaben. Für Toleranzen gelten ausschließlich unsere Lieferungs- und Zahlungsbedingungen. Wir empfehlen daher zu prüfen, ob die in dieser Druckschrift genannten Angaben für Ihre vorgesehene technische Lösung geeignet sind.

Anwendung, Verwendung und Verarbeitung unserer Produkte erfolgen außerhalb unserer Kontrollmöglichkeiten und liegen daher ausschließlich in Ihrem Verantwortungsbereich. Unsere Gewährleistung bezieht sich daher in jedem Fall auf die

gleichbleibende Qualität unserer Produkte entsprechend unserer Spezifikation. Sollte eine Haftung in Frage kommen, so richtet sich diese nach unseren Ihnen bekannten allgemeinen Lieferungs- und Zahlungsbedingungen. Diese sind auch abrufbar unter <http://rehau.de/lzb> oder werden auf Anfrage zugesandt. Für Schäden, die aus der Verwendung von anderen als in unseren Unterlagen aufgeführten Original-System-Zubehörteilen herrühren, ist jede Gewährleistung und Haftung von REHAU ausgeschlossen.